

Category		Title
NFR:	2.B	Chemical industry
including	2.B.1	Ammonia production
	2.B.2	Nitric acid production
	2.B.3	Adipic acid production
	2.B.4	Carbide production
	2.B.5.a	Other chemical industry
	2.B.5.b	Storage, handling, transport of chemical products
SNAP:	0404 0405	Processes in inorganic chemical industries Process in organic chemical industry (bulk production)
ISIC:		
Version	Guidebook 2009 update March 2013	
Update history	Updated March 2013 For details of past updates please refer to the chapter update log available at the online Guidebook website http://eea.europa.eu/emep-eea-guidebook	

Coordinator

Jeroen Kuenen

Contributing authors (including to earlier versions of this chapter)

Wilfred Appelman, Otto Rentz, Dagmar Oertel, Jan Berdowski, Jan Jonker, Jan Pieter Bloos, Stephen Richardson, Neil Passant, S. Pittman, Mike Woodfield and Pieter van der Most

Contents

1	Overview	3
2	Description of sources.....	4
2.1	General: processes in the chemical industry	4
2.2	Techniques	10
2.3	Emissions	10
2.4	Controls.....	11
3	Methods.....	12
3.1	Choice of method.....	12
3.2	Tier 1 default approach	13
3.3	Tier 2 technology-specific approach.....	16
3.4	Tier 3 emission modelling and use of facility data	52
4	Data quality	54
4.1	Completeness	54
4.2	Avoiding double counting with other sectors	54
4.3	Verification	55
4.4	Developing a consistent time series and recalculation.....	59
4.5	Uncertainty assessment	60
4.6	Inventory quality assurance/quality control (QA/QC)	60
4.7	Gridding	60
4.8	Reporting and documentation	60
5	Glossary	60
6	References.....	61
7	Point of enquiry.....	62

1 Overview

The present chapter gives guidance for estimating emissions that result from the production of various inorganic and organic chemicals. The following processes are described under sub-sector 2.B Chemical industry (SNAP codes are included):

- Ammonia production (source category 2.B.1)
 - 040403 Ammonia
- Nitric acid production (source category 2.B.2)
 - 040402 Nitric acid
- Adipic acid production (source category 2.B.3)
- Calcium carbide production (source category 2.B.4)
 - 040412 Calcium carbide production
- Other chemical industry (source category 2.B.5.a)
 - 0404 040401 Sulphuric acid
 - 040404 Ammonium sulphate
 - 040405 Ammonium nitrate
 - 040406 Ammonium phosphate
 - 040407 NPK fertilisers
 - 040408 Urea
 - 040409 Carbon black
 - 040410 Titanium dioxide
 - 040411 Graphite
 - 040413 Chlorine production
 - 040414 Phosphate fertilisers
 - 040416 Other
 - 0405 040501 Ethylene
 - 040502 Propylene
 - 040503 1,2 dichloroethane (except 04.05.05)
 - 040504 Vinylchloride (except 04.05.05)
 - 040505 1,2 dichloroethane + vinylchloride (balanced
 - 040506 Polyethylene Low Density
 - 040507 Polyethylene High Density
 - 040508 Polyvinylchloride
 - 040509 Polypropylene
 - 040510 Styrene
 - 040511 Polystyrene
 - 040512 Styrene butadiene
 - 040513 Styrene-butadiene latex
 - 040514 Styrene-butadiene rubber (SBR)
 - 040515 Acrylonitrile Butadiene Styrene (ABS) resins
 - 040516 Ethylene oxide

	040517	Formaldehyde
	040518	Ethylbenzene
	040519	Phtalic anhydride
	040520	Acrylonitrile
	040521	Adipic acid
	040523	Glyoxylic acid
	040525	Pesticide production
	040526	Production of persistent organic compounds
	040527	Other (phytosanitary, ...)
0406	040622	Explosives manufacturing

- Storage, handling, transport of chemical products (source category 2.B.5.b)

040415 Storage and handling of inorganic chemical

The present edition of the Guidebook provides default emission factors for the 2.B Chemical industry source category, based on referenced or non-referenced literature values or, if no literature is available, expert judgement. The chemical industry is for most pollutants only a minor source of emissions and in the previous version of the Guidebook it was considered insignificant.

2 Description of sources

2.1 General: processes in the chemical industry

The present sub-section describes the processes in different chemical industries under source categories 2.B.1–5. Although the products can be very different, all processes in the chemical industry consist basically of a series of comparable unit operations. In chemical engineering and related fields, a unit operation is a basic step in a process. For example in ammonia (NH₃) production the gasification, reforming and the NH₃ synthesis are each unit operations that are connected to create the overall process. A process may have many unit operations to obtain the desired product. Chemical engineering unit operations can be divided into three major basic categories of equipment:

- combination (mixing);
- separation (distillation and other separations);
- reaction (chemical reaction).

Additionally, they may be indexed by physical nature:

- fluid flow processes;
- heat transfer processes;
- mass transfer processes;
- thermodynamic processes;
- mechanical processes.

Chemical engineering unit operations and unit processing form the main principles of all chemical industries and are the foundation of designs of chemical plants, factories, and equipment used.

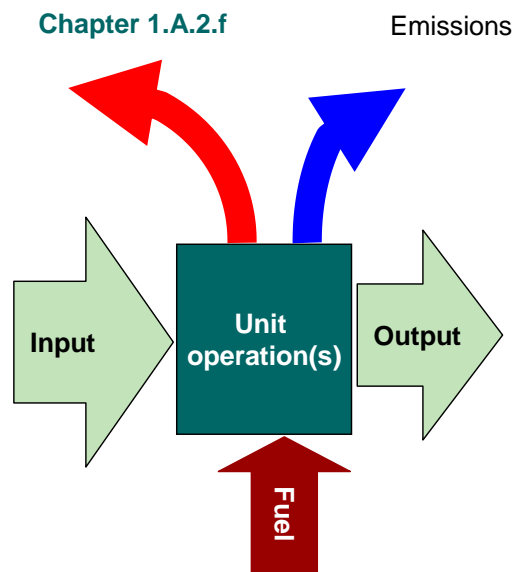

Figure 2.1 Simplified process scheme of production in the chemical industry

Processes in chemical industries are usually also highly integrated and linked, as can be seen in Figure 2.2, which illustrates the interdependency of different inorganic chemical processes.

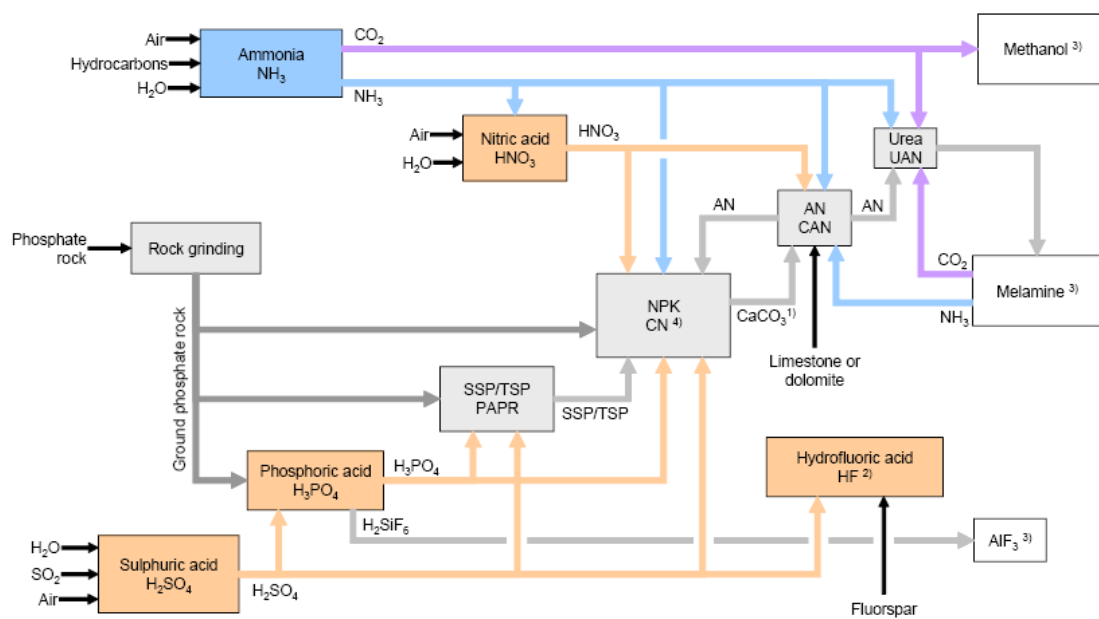

Figure 1: Overview of boundaries and links between the LVIC-AAF industries

¹⁾ only with NPK production using the nitrophosphate route ²⁾ not typically produced on fertiliser sites ³⁾ not described in this document
⁴⁾ CN is $\text{Ca}(\text{NO}_3)_2$, and is alternatively produced by neutralisation of HNO_3 with lime (not described in this document)

Figure 2.2 Example of integration of processes in the chemical industry (EC, 2006b)

In sub-sections 2.1.1–2.1.5 the production of a few important chemical products is discussed, specifically ammonia (source category 2.B.1), nitric acid (2.B.2), adipic acid (2.B.3) and calcium carbide (2.B.4). Other processes in the chemical industry are summarised in sub-section 2.1.5, while paragraph 2.1.6 describes emission sources from typical operations in storage, handling, and transport of chemical products (2.B.5.b).

2.1.1 Ammonia production (source category 2.B.1)

The process of ammonia production is based on the ammonia synthesis loop (also referred to as the Haber-Bosch process) reaction of nitrogen (derived from process air) with hydrogen to form anhydrous liquid ammonia. The hydrogen is derived from feedstock as natural gas (conventional steam reforming route) or sometimes uses other fuel feedstock as residual oil or coke (partial oxidation) that is being gasified and purified.

The processes used in producing the hydrogen are removal of sulphur compounds from the feedstock (sulphur deactivates the catalysts used in subsequent steps), catalytic steam reforming of the sulphur-free feedstock to form hydrogen plus carbon monoxide (syngas) and finally a shift reaction with water to convert the carbon monoxide into carbon dioxide and more hydrogen. The carbon dioxide is removed by absorption (in aqueous ethanolamine solutions) or by adsorption (pressure swing absorbers (PSA)). Catalytic methanation is used to remove any small residual amounts of carbon monoxide or carbon dioxide from the hydrogen.

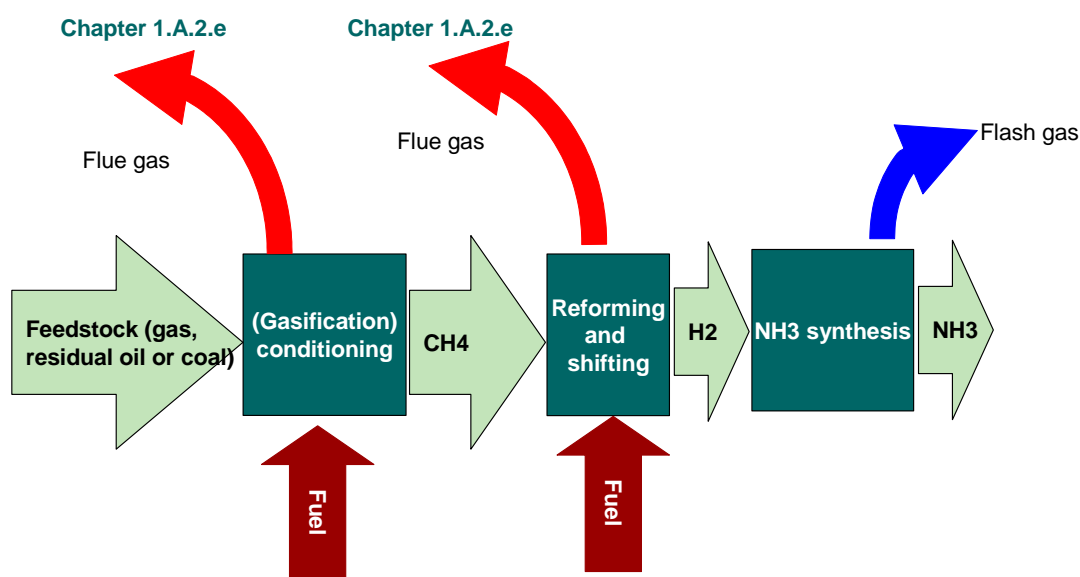

Figure 2.3 Simplified process scheme of ammonia production

2.1.2 Nitric acid production (source category 2.B.2)

Nitric acid production is a large scale process in the chemical industry. The process involves the catalytic oxidation of ammonia by air (oxygen) yielding nitrogen oxide then oxidised into nitrogen dioxide (NO_2) and absorbed in water. The reaction of NO_2 with water and oxygen forms nitric acid (HNO_3) with a concentration of generally 50–75 wt.% ('weak acid'). For the production of highly concentrated nitric acid (98 wt.%), first nitrogen dioxide is produced as described above. It is then absorbed in highly concentrated acid, distilled, condensed and finally converted into highly concentrated nitric acid at high pressure by adding a mixture of water and pure oxygen.

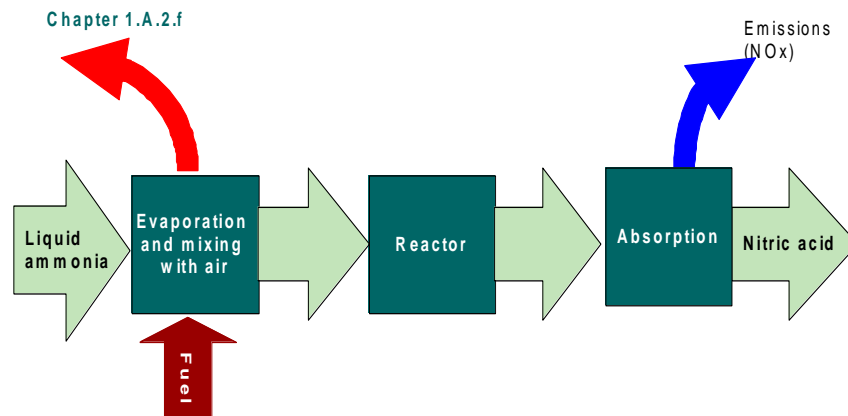

Figure 2.4 Simplified process scheme of nitric acid production

For nitrogen oxide (NO_x) emissions, the relevant process units are the absorption tower and the tail gas cleaning units, e.g. selective catalytic or non-catalytic reduction (SCR, SNCR). Small amounts of NO_x are also lost for acid concentrating plants.

The NO_x emissions ('nitrous gases') contain a mixture of nitric oxide (NO) and nitrogen dioxide (NO₂), dinitric oxide (N₂O₃) and dinitric tetroxide (N₂O₄). Emissions of N₂O have to be reported separately.

2.1.3 Adipic acid production (source category 2.B.3)

Adipic acid is primarily used in the production of nylon, as well as in the manufacturing of polyurethanes and polyester resins. Adipic acid is produced from cyclohexane. Cyclohexane is used to produce KA, a mixture of cyclohexanol and cyclohexanone. KA is then oxidised with nitric acid to produce adipic acid. Adipic acid is primarily used for the manufacturing of 6.6-nylon. Current commercial adipic acid is produced from cyclohexane by two oxidation steps:

Step one: cyclohexane + O₂ → cyclohexanol and cyclohexanone

Step two: cyclohexanol/cyclohexanone + nitric acid + air → adipic acid + nitrous oxide

Adipic acid production is relevant for emissions of greenhouse gases (N₂O) but not considered significant for other air emissions included in the protocols.

2.1.4 Calcium carbide production (source category 2.B.4)

Calcium carbide (CaC₂) is manufactured by heating a lime and carbon mixture up to 2100 °C in an electric arc furnace. The lime is reduced by carbon to calcium carbide and carbon monoxide. Lime for the reaction is usually made by calcining limestone in a kiln at the plant site. The sources of carbon for the reaction are petroleum coke, metallurgical coke and anthracite coal.

The process for manufacturing calcium carbide is illustrated in Figure 2.5.

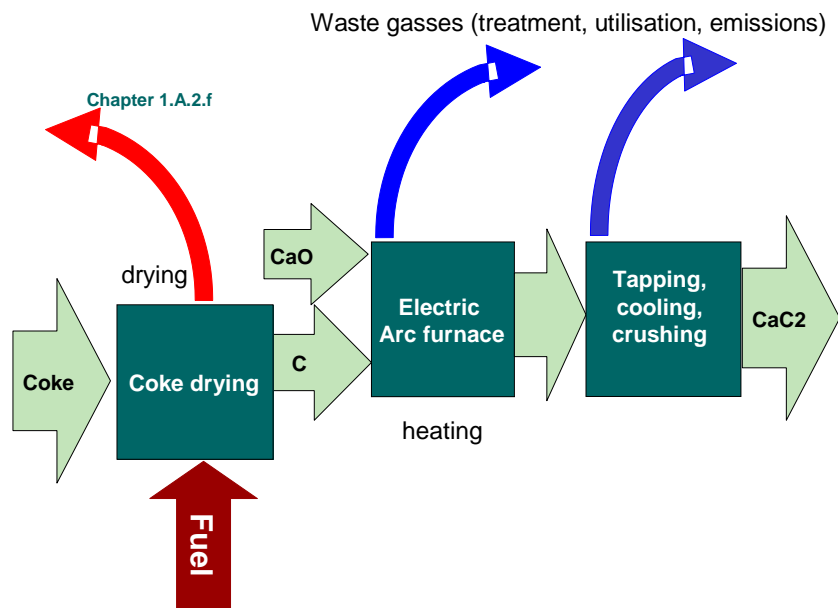

Figure 2.5 Simplified process scheme of calcium carbide production (EC, 2006c; EPA, 1993)

2.1.5 Other chemical industry (source category 2.B.5.a)

Source category 2.B.5.a Other chemical industry includes a large collection of different chemical production processes, listed with their snap codes in section 1 above. Although processes differ substantially, the processes are again basically sets of unit operations as described in sub-section 2.1. In terms of emissions, a distinction can be made between inorganic and organic processes. Emissions from inorganic processes will mostly consist of particulate matter while emissions from organic processes will mostly consist of non-methane volatile organic compounds (NMVOC).

Short process descriptions are provided in the paragraphs under 3.3.2.5, except for the process of sulphuric acid production, which is one of the most important large scale chemical processes. Figure 2.6 provides a process scheme of activities at a sulphuric acid plant:

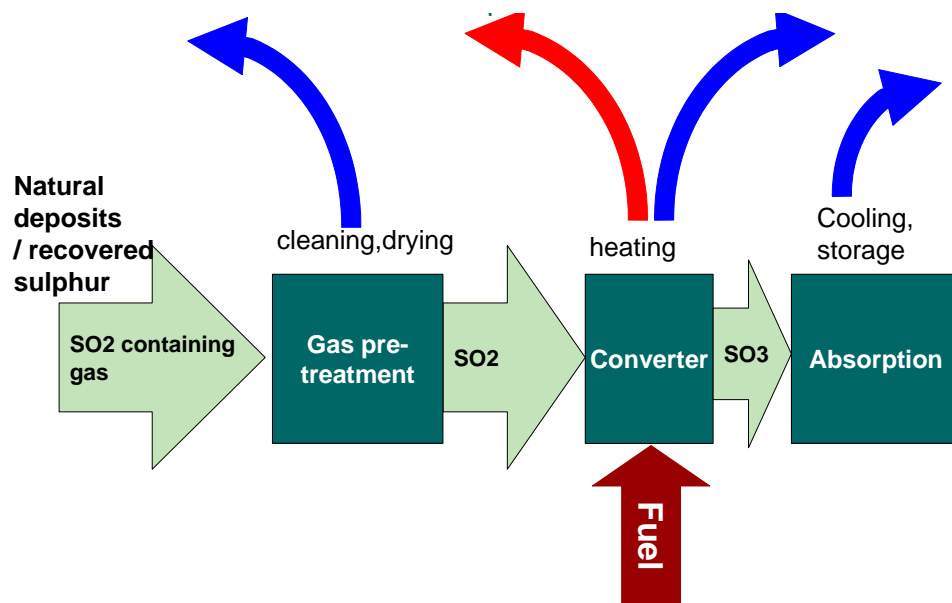

Figure 2.6 Process scheme sulphuric acid plant

For sulphur dioxide (SO₂) emissions the relevant process units are the cleaning of raw gas containing SO₂ (gas pre-treatment), the catalytic oxidation to sulphur trioxide (SO₃) (converter) and final absorbing tower and scrubbers. Scrubbers may be installed for the cleaning of raw gas and behind the tail gas cleaning.

In principle the commercial production of sulphuric acid includes the following steps:

Step one: production of gases containing SO₂ and cleaning of the gases obtained if necessary;

Step two: oxidation of SO₂ to SO₃;

Step 3: absorption of the SO₃ obtained in water.

The main relevant pollutants are sulphuric oxides (SO_x), which include sulphur dioxide and sulphur trioxide. SO₂ and SO₃ should be reported together expressed as SO₂. Emissions of nitrogen oxides (NO_x), non-methane volatile organic compounds (NMVOC),⁽¹⁾ carbon monoxide (CO) and ammonia (NH₃) are negligible.^(2,3) Emissions of heavy metals (e.g. from roasting sulphur in the smelter gas) are not relevant due to the fact that most of them are particle bound and separated by the wet gas cleaning (e.g. electrostatic precipitation). Heavy metals remaining in the flue gas are mostly absorbed by the sulphuric acid formed in the converter.

SO₂ emissions are released from the production of gases containing SO₂ (raw gas preparation),⁽⁵⁾ the oxidation of SO₂ to SO₃ (converter) and the absorption of SO₃ obtained (H₂SO₄ production).

Nearly all sulphur dioxide emissions from sulphuric acid plants are found in the exit stack gases. In addition to these, small quantities of sulphur oxides are emitted from storage tank vents as well as from tank truck vents during loading operations, from sulphuric acid concentrators and through leaks in process equipment. Few data are available on the quantity of emissions from these non-stack sources.

Control measures are an integral part of the production process. Control measures include the oxidising gas scrubbing process and the tail gas scrubbing with NH₃.

The emissions contain sulphur dioxide and sulphur trioxide depending on the efficiency of converting sulphur dioxide to sulphur trioxide.

2.1.6 Storage, handling, transport of chemical products (2.B.5.b)

Source category 2.B.5.b includes processes in storage and handling of inorganic chemical products (SNAP 040415) and organic chemical products (SNAP040522).

Detailed information on emission sources may be found in the Integrated Pollution Prevention and Control (IPPC) Best Available Technique Reference (BREF) document on emissions from storage of bulk or dangerous materials (EC, 2006a), but in general terms emissions may arise from:

-
- ⁽¹⁾ The production of organic compounds gives rise to spent sulphuric acid which may contain organic compounds, salts etc. Depending on the type and degree of contamination, spent sulphuric acid is decomposed and processed to sulphuric acid in a contact plant. Slightly contaminated dilute acids can be concentrated to between 65 and 75 wt.% and then subsequently evaporated to a concentration of ca. 96 wt. %.
 - ⁽²⁾ Oleum plants also produce mist emissions of sulphuric acid.
 - ⁽³⁾ For sulphuric acid production only SO₂ is relevant. Other pollutants may be released from the preparation of SO₂ feed gas (roasting, smelting etc.), which are not covered here.

- tank losses from displacement during filling and breathing during ambient temperature changes (mainly NMVOCs with rate of loss depending on vapour pressure);
- loading/unloading of containers and vessels (tankers for road, rail and boat);
- blanket gases used in storage tanks;
- particulate losses from conveyors;
- evaporative losses from spills.

2.2 Techniques

The techniques used in chemical processing can be regarded as unit operations, as described above in sub-section 2.1. Depending on the nature of the process these operations can include general basic equipment (heat exchangers, distilling towers) or highly specialised equipment such as high pressure multiphase reactors with internal mixing. For more information on unit operations and processes used in chemical industry see, for example, encyclopaedias on the chemical industry.

2.3 Emissions

The main air pollutants from chemical processing are:

- sulphur oxides (SO₂, SO₃) and other sulphur compounds (H₂S, CS₂, COS);
- nitrogen oxides (NO_x, N₂O) and other nitrogen compounds (NH₃, HCN)
- halogens and their compounds (Cl₂, Br₂, HF, HCl, HBr)
- volatile organic compounds (VOC)

Emissions from chemical processing can roughly be divided into ducted and non-ducted (diffuse, fugitive) emissions. (EC, 2003a)

Waste gas and exhaust air emissions in the chemical industry comprise:

- ducted emissions, such as:
 - process emissions released through a vent pipe by the process equipment and inherent to the running of the plant;
 - flue gases from energy-providing units, such as process furnaces, steam boilers, combined heat and power units, gas turbines, gas engines;
 - waste gases from emission control equipment, such as filters, incinerators or absorbers, likely to contain unabated pollutants or pollutants generated in the abatement system;
 - tail gases from reaction vessels and condensers;
 - waste gases from catalyst regeneration;
 - waste gases from solvent regeneration;
 - waste gases from vents from storage and handling (transfers, loading and unloading) of products, raw materials and intermediates;
 - waste gases from purge vents or pre-heating equipment, which are used only on start-up or shutdown operations;
 - discharges from safety relief devices (e.g. safety vents, safety valves);
 - exhaust from general ventilation system;
 - exhaust from vents from captured diffuse and/or fugitive sources, e.g. diffuse sources;
 - installed within an enclosure or building.
- diffuse (un-ducted) emissions, arising from point, linear, surface or volume sources under normal operating circumstances, also known as fugitive:

- process emissions from the process equipment and inherent to the running of the plant, released from a large surface or through openings, etc.;
- non-ducted emissions (e.g. working losses and breathing losses, when not captured and ducted) from storage equipment and during handling operations (e.g. filling of drums, trucks or containers);
- non-routine emissions, resulting from operations other than the routine processing of the facility, including emissions during start-up or shutdown, and during maintenance;
- emissions from flares;
- secondary emissions, resulting from the handling or disposal of waste (e.g. volatile material from sewers, waste water handling facilities or cooling water);
- equipment leaks from pump and compressor seals, valves, flanges, connectors and other piping items, or other equipment items, such as drain or vent plugs or seals.

The methods set out below in section 3 exclude emissions from the combustion of fuels inside the process or to generate heat or electricity, which are covered under Chapter 1.A.2 Combustion in Manufacturing Industries and Construction.

2.4 Controls

Only ducted emissions can be controlled. Examples of controls/abatement in the chemical industry are:

- waste gas combustion units (e.g. flares, incinerators) may produce secondary pollutants that did not exist in the original waste stream (e.g. dioxins, particulates), as well as combustion gases;
- stripping of waste water (with air or steam) will transfer dissolved organics into the gaseous phase;
- NMVOCs from waste water collection systems (e.g. drains, balancing tanks);
- NMVOCs from waste water treatment facilities (e.g. vaporisation of NMVOCs in biological treatment units);
- NMVOCs and particulates from storage and treatment of solid wastes.

Certain controls may produce secondary pollutants that did not exist in the original waste stream (e.g. dioxins, particulates and combustion gases from waste incineration).

As far as diffuse and fugitive emissions are concerned the objective of emission abatement is prevention and/or minimisation through recovery and good practice. Fugitive emissions can be reduced through a Leak Detection And Repair programme (LDAR) (EGTEI, 2005).

The LDAR technique consists of measuring the VOC concentration in the atmosphere around the potential leaking point, then selecting equipments leaking over a defined threshold value and finally operating a repair on those leaking items.

More information on abatement in the chemical industry can be found in the Best Available Technique Reference (BREF) documents on the various chemical industries, as well as a dedicated BREF document on abatement.⁽⁴⁾

⁽⁴⁾ EC, 2003a

3 Methods

3.1 Choice of method

Figure 3.1 presents the procedure to select the methods for estimating process emissions from the chemical industry. The basic procedure is as follows:

- If detailed information is available: use it.
- If the source category is a key category, a Tier 2 or better method must be applied and detailed input data must be collected. The decision tree directs the user in such cases to the Tier 2 method, since it is expected that it is more easy to obtain the necessary input data for this approach than to collect facility level data needed for a Tier 3 estimate
- The alternative of applying a Tier 3 method using detailed process modelling is not explicitly included in this decision tree. However, detailed modelling will always be done at facility level and results of such modelling could be seen as ‘facility data’ in the decision tree.

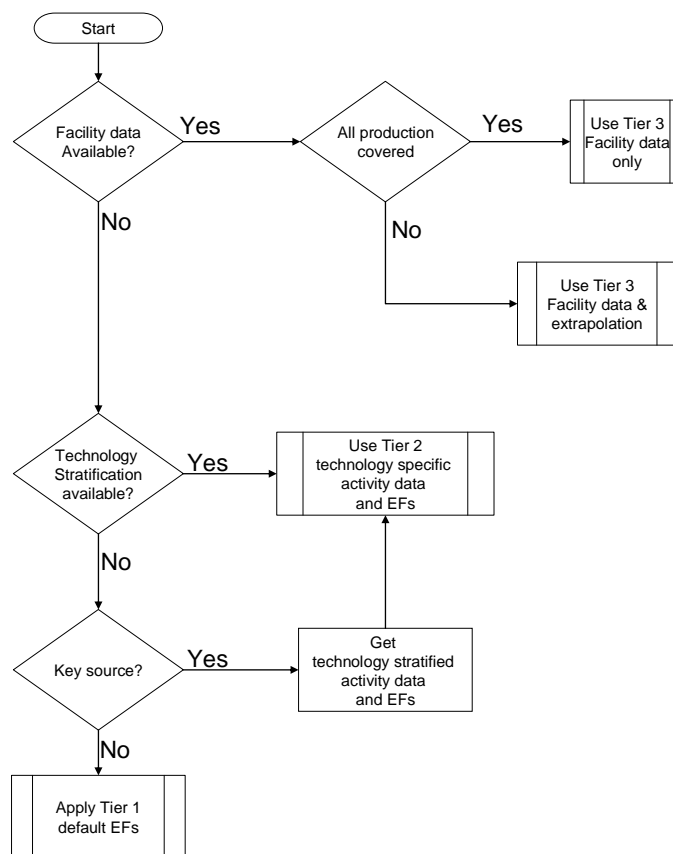

Figure 3.1 Decision tree for sub-sector 2.B Chemical industry

As many of these sources are particularly unique, Tier 3 methods may be easier and better to apply than Tier 2 or even Tier 1. It is often easier to go straight to the plant operators and regulators to get plant-specific information rather than applying more abstract Tier 2 methods. However, if a category is a key category, Tier 3 is not feasible and Tier 2 methods below are unavailable, the country should investigate collecting representative emission factors for the national emissions using measurement programmes or measurements taken for permitting.

3.2 Tier 1 default approach

3.2.1 Algorithm

The Tier 1 approach uses the general equation:

$$E_{\text{pollutant}} = AR_{\text{production}} \times EF_{\text{pollutant}} \quad (1)$$

This equation is applied at the national level, using annual national total chemical production. Information on the production of chemical compounds, suitable for estimating emissions using the simpler estimation methodology (Tier 1 and 2), is widely available from United Nations statistical yearbooks or national statistics.

The Tier 1 emission factors assume an averaged or typical technology and abatement implementation in the country and integrate all sub-processes in the chemical industry between inputting raw material and the final shipment off the facilities.

In cases where specific abatement options are to be taken into account a Tier 1 method is not applicable and a Tier 2 or Tier 3 approach must be used.

3.2.2 Default tier 1 emission factors

Paragraph sub-sections 3.2.2.1–3.2.2.5 below set out default Tier 1 emission factors for chapters 2.B.1–2.B.5. These Tier 1 emission factors also include emissions of storage, handling and transport of chemical products. When using these Tier 1 emission factors, double counting with emissions from source category 2.B.5.b should be avoided.

Many emission factors in this chapter derive from the European Commission's Integrated Pollution Prevention and Control (IPPC) Best Available Technique Reference (BREF) documents. In most instances, emission factors in the BREF documents are given as ranges. In the Tier 1 and Tier 2 emission factor tables in this Guidebook, these are interpreted as the 95 % confidence interval, and when no estimate for the value is available, the geometric mean of the range has been used for the emission factor value.

3.2.2.1 Ammonia production (source category 2.B.1)

For the three primary sources of the pollutants nitrogen oxides, ammonia and carbon monoxide, Tier 1 emission factors, based on various literature data and compiled from various types of processes, are given in Table 3.1 below.

Table 3.1 Tier 1 emission factors for source category 2.B.1 Ammonia production

Tier 1 default emission factors					
NFR Source Category	Code	Name			
	2.B.1	Ammonia production			
Fuel	NA				
Not applicable	TSP, PM10, Pb, Cd, Hg, As, Cr, Cu, Ni, Se, Zn, Aldrin, Chlordane, Chlordecone, Dieldrin, Endrin, Heptachlor, Heptabromo-biphenyl, Mirex, Toxaphene, HCH, DDT, PCB, PCDD/F, Benzo(a)pyrene, Benzo(b)fluoranthene, Benzo(k)fluoranthene, Indeno(1,2,3-cd)pyrene, Total 4 PAHs, HCB, PCP, SCCP				
Not estimated	NMVOC, SOx, PM2.5				
Pollutant	Value	Unit	95% confidence interval		Reference
			Lower	Upper	
NOx	1	kg/t NH3	0.05	334	IPPC BREF LVC AAF (2006)
CO	0.1	kg/t NH3	0.05	0.2	IPPC BREF LVC AAF (2006)
NH3	0.01	kg/t NH3	0.006	0.032	IPPC BREF LVC AAF (2006)

3.2.2.2 Nitric acid production (source category 2.B.2)

Table 3.2 contains a Tier 1 emission factor for NO_x from nitric acid production based on various literature data and compiled from various types of processes as low pressure (<1.7 bar), medium pressure and high pressure (>8 bar) plants.

Table 3.2 Tier 1 emission factor for source category 2.B.2 Nitric acid production

Tier 1 default emission factors					
NFR Source Category	Code	Name			
	2.B.2	Nitric acid production			
Fuel	NA				
Not applicable	CO, NMVOC, SO _x , TSP, PM10, Pb, Cd, Hg, As, Cr, Cu, Ni, Se, Zn, Aldrin, Chlordane, Chlordecone, Dieldrin, Endrin, Heptachlor, Heptabromo-biphenyl, Mirex, Toxaphene, HCH, DDT, PCB, PCDD/F, Benzo(a)pyrene, Benzo(b)fluoranthene, Benzo(k)fluoranthene, Indeno(1,2,3-cd)pyrene, Total 4 PAHs, HCB, PCP, SCCP				
Not estimated	NH ₃ , PM2.5				
Pollutant	Value	Unit	95% confidence interval		Reference
			Lower	Upper	
NO _x	10000	g/Mg prod., 100% Acid	500	15000	BREF LVIC AAF (2007)

NO_x emissions vary considerably depending on the type of control equipment and the process conditions.

3.2.2.3 Adipic acid production (source category 2.B.3)

Adipic acid production is relevant for emissions of greenhouse gases (N₂O) and although emission factors are provided, they are not considered significant for other air emissions included in the protocols.

Table 3.3 Tier 1 emission factors for source category 2.B.3 Adipic acid production

Tier 1 default emission factors					
NFR Source Category	Code	Name			
	2.B.3	Adipic acid production			
Fuel	NA				
Not applicable	NMVOC, SO _x , NH ₃ , TSP, PM10, Pb, Cd, Hg, As, Cr, Cu, Ni, Se, Zn, Aldrin, Chlordane, Chlordecone, Dieldrin, Endrin, Heptachlor, Heptabromo-biphenyl, Mirex, Toxaphene, HCH, DDT, PCB, PCDD/F, Benzo(a)pyrene, Benzo(b)fluoranthene, Benzo(k)fluoranthene, Indeno(1,2,3-cd)pyrene, Total 4 PAHs, HCB, PCP, SCCP				
Not estimated	PM2.5				
Pollutant	Value	Unit	95% confidence interval		Reference
			Lower	Upper	
NO _x	8	kg/Mg	4	16	US EPA AP42
CO	0.4	kg/Mg	0.2	0.8	US EPA AP42

3.2.2.4 Calcium carbide production (source category 2.B.4)

The main emissions from the production of calcium carbide (CaC₂) are dust. NO_x emissions arise mainly from the combustion of the CO rich furnace gas but are to be reported under source category 1.A.2. Emissions of dust can be encountered at various stages over the whole production process. The main source of dust emissions is dust-laden furnace gas.

Table 3.4 Tier 1 emission factors for source category 2.B.4 Calcium carbide production

Tier 1 default emission factors					
	Code	Name			
NFR Source Category	2.B.4	Carbide production			
Fuel	NA				
Not applicable	NH ₃ , Aldrin, Chlordane, Chlordecone, Dieldrin, Endrin, Heptachlor, Heptabromo-biphenyl, Mirex, Toxaphene, HCH, DDT, PCB, PCP, SCCP				
Not estimated	NO _x , CO, NMVOC, SO _x , PM ₁₀ , PM _{2.5} , Pb, Cd, Hg, As, Cr, Cu, Ni, Se, Zn, PCDD/F, Benzo(a)pyrene, Benzo(b)fluoranthene, Benzo(k)fluoranthene, Indeno(1,2,3-cd)pyrene, Total 4				
Pollutant	Value	Unit	95% confidence interval		Reference
			Lower	Upper	
TSP	100	g/Mg product	50	150	IPPC BREF LVIC SAO

3.2.2.5 Other chemical industry (source category 2.B.5.a)

The source category 2.B.5.a Other chemical industry includes a large collection of different chemical production processes, listed in section 1 above with corresponding SNAP codes. Emissions from inorganic processes will mostly consist of particulate matter while emissions from organic processes will mostly consist of NMVOCs.

Table 3.5 presents Tier 1 emission factors for 2.B.5.a Other chemical industry. The emission factors are derived using reported emission data in the European Pollutant Emission Register (EPER)⁽⁵⁾ for the chemical industry and combining these with activity data from Eurostat⁽⁶⁾ for the EU-25. There are unavoidable uncertainties associated with this approach:

- EPER emissions have not always been properly audited and validated and significant errors in some EPER data points have been noted previously (EC, 2007);
- EPER emissions data do not take account of emissions of those facilities whose emissions are under the respective pollutant thresholds;
- as EPER does not provide information on activity data those data were taken from Eurostat statistics but no exact correspondence can be established with the activity data of the corresponding EPER emissions reporting facilities.

The NACE codes used are 2413 for basic organic chemicals and 2414 and 2415 for basic inorganic chemicals, excluding the Prodcom (sub-NACE) codes for ammonia, nitric acid, adipic acid and calcium carbide production since for these four categories the Tier 1 emission factors are listed in sub-sections 3.2.2.1 to 3.2.2.4 above.

Table 3.5 Tier 1 emission factors for source category 2.B.5.a Other chemical industry

Tier 1 default emission factors					
	Code	Name			
NFR Source Category	2.B.5.a	Other chemical industry (Please specify the sources included/excluded in the notes column to the right)			
Fuel	NA				
Not applicable					
Not estimated	NO _x , CO, SO _x , NH ₃ , PM ₁₀ , PM _{2.5} , Pb, Cd, Hg, As, Cr, Cu, Ni, Se, Zn, Aldrin, Chlordane, Chlordecone, Dieldrin, Endrin, Heptachlor, Heptabromo-biphenyl, Mirex, Toxaphene, HCH, DDT, PCB, PCDD/F, Benzo(a)pyrene, Benzo(b)fluoranthene, Benzo(k)fluoranthene, Indeno(1,2,3-cd)pyrene, Total 4 PAHs, HCB, PCP, SCCP				
Pollutant	Value	Unit	95% confidence interval		Reference
			Lower	Upper	
NMVOC	8	kg/ton	1	20	EPER/Eurostat
TSP	50	kg/ton	10	200	EPER/Eurostat

⁽⁵⁾ EPER website: <http://eper.ec.europa.eu/>

⁽⁶⁾ Statistics on the production of manufactured goods — annual volume 2004: www.eurostat.com

3.2.2.6 Storage, handling, transport of chemical products (source category 2.B.5.b)

Tier 1 emission factors for estimating emissions of storage, handling and transport of chemical products (2.B.5.b) are not provided since coverage of these emissions is included elsewhere (source categories 2.B.1–2.B.5.a). All default Tier 1 emission factors for the chemical industry also include storage and handling in production

3.2.3 Activity data

Information on the production of chemicals suitable for estimating emissions using the simpler estimation methodology (Tier 1 and 2), is widely available from United Nations statistical yearbooks or national statistics.

Further guidance is provided in the 2006 IPCC Guidelines for National Greenhouse Gas Inventories, volume 3 on Industrial Processes and Product Use (IPPU), chapter 2.2.1.3 ‘Choice of activity statistics’.

3.3 Tier 2 technology-specific approach

3.3.1 Algorithm

The Tier 2 approach is similar to the Tier 1 approach. To apply the Tier 2 approach, both the activity data and the emission factors need to be stratified according to the different processes that may occur in the country. These techniques may include:

- different products;
- dust capture;
- any other emission abatement technologies implemented in the country.

The Tier 2 approach is as follows:

Stratify the production in the country to model the different product and process types occurring in the national industry into the inventory by:

- defining the production using each of the separate product and/or process types (together called ‘technologies’ in the formulae below) separately; and
- applying technology-specific emission factors for each process type:

$$E_{\text{pollutant}} = \sum_{\text{technologies}} AR_{\text{production,technology}} \times EF_{\text{technology,pollutant}} \quad (2)$$

where:

$AR_{\text{production,technology}}$ = the production rate within the source category, using this specific technology

$EF_{\text{technology,pollutant}}$ = the emission factor for this technology and this pollutant

A country where only one technology is implemented will result in a penetration factor of 100 % and the algorithm in equation (2) reduces to:

$$E_{\text{pollutant}} = AR_{\text{production}} \times EF_{\text{technology,pollutant}} \quad (3)$$

where:

$E_{\text{pollutant}}$	=	the emission of the specified pollutant
$AR_{\text{production}}$	=	the activity rate for the production
$EF_{\text{pollutant}}$	=	the emission factor for this pollutant

The emission factors in this approach will still include all sub-processes within the industry from inputting the raw materials until the product is shipped to the customers.

3.3.2 *Technology-specific emission factors*

Applying a Tier 2 approach for the process emissions from chemical production, technology-specific emission factors are needed. These are provided in the present sub-section. A BREF document for this industry is available at <http://eippcb.jrc.es/pages/FActivities.htm>. Section 4.3.1 contains emission factors derived from the associated emission levels (AELs) as defined in the BREF document for comparison.

This sub-section provides a series of technology-specific emission factors for the processes in the chemical industry.

Many emission factors in this sub-sector are adopted from IPPC BREF documents. In most instances, emission factors in the BREF documents are given as ranges. In the Tier 1 and Tier 2 emission factor tables in the Guidebook, these are interpreted as the 95 % confidence interval, and when no estimate for the value is available, the geometric mean of the range has been used for the emission factor value.

3.3.2.1 **Ammonia production (source category 2.B.1)**

Emissions to the atmosphere from ammonia plants include nitrogen oxides (NO_x), carbon monoxide (CO), carbon dioxide (CO₂), hydrogen sulphide (H₂S), volatile organic compounds (NMVOCs), particulate matter, methane, hydrogen cyanide, and ammonia.

Two major processes are used in ammonia production, steam reforming and partial oxidation, depending on the feedstock used in generating hydrogen. Natural gas is used as feedstock in the (conventional) steam reforming route, while the partial oxidation route used feedstock as residual oil or coke.

Ammonia tank farms can release more than 10 kg of ammonia per tonne of ammonia produced. Emissions of ammonia from the process have been reported to range from less than 0.04 to 2 kg/t of ammonia produced. Energy consumption ranges from 29 to 36 gigajoules per metric ton (GJ/t) of ammonia. (Cheremisinoff, 2002)

Table 3.6 Tier 2 emission factors for source category 2.B.1 ammonia production, steam reforming (040403)

Tier 2 emission factors					
NFR Source Category	Code	Name			
	2.B.1	Ammonia production			
Fuel	NA				
SNAP (if applicable)	040403	Ammonia			
Technologies/Practices	steam reforming, conventional as well as advanced processes				
Region or regional conditions					
Abatement technologies					
Not applicable	TSP, PM10, Pb, Cd, Hg, As, Cr, Cu, Ni, Se, Zn, Aldrin, Chlordane, Chlordecone, Dieldrin, Endrin, Heptachlor, Heptabromo-biphenyl, Mirex, Toxaphene, HCH, DDT, PCB, PCDD/F, Benzo(a)pyrene, Benzo(b)fluoranthene, Benzo(k)fluoranthene, Indeno(1,2,3-cd)pyrene, Total 4 PAHs, HCB, PCP, SCCP				
Not estimated	SOx, PM2.5				
Pollutant	Value	Unit	95% confidence interval		Reference
			Lower	Upper	
NOx	1	kg/ton NH3	0.3	1.3	IPPC BREF LVIC AAF
CO	0.006	kg/ton NH3	0.002	0.02	IPPC BREF LVIC AAF
NM VOC	0.09	kg/ton NH3	0.01	0.3	IPPC BREF LVIC AAF
NH3	0.05	kg/ton NH3	0.001	0.1	IPPC BREF LVIC AAF

Table 3.7 Tier 2 emission factors for source category 2.B.1 Ammonia production, partial oxidation (040403)

Tier 2 emission factors					
NFR Source Category	Code	Name			
	2.B.1	Ammonia production			
Fuel	NA				
SNAP (if applicable)	040403	Ammonia			
Technologies/Practices	partial oxidation				
Region or regional conditions					
Abatement technologies	various(auxiliary boiler, superheater, post combustion)				
Not applicable	TSP, PM10, Pb, Cd, Hg, As, Cr, Cu, Ni, Se, Zn, Aldrin, Chlordane, Chlordecone, Dieldrin, Endrin, Heptachlor, Heptabromo-biphenyl, Mirex, Toxaphene, HCH, DDT, PCB, PCDD/F, Benzo(a)pyrene, Benzo(b)fluoranthene, Benzo(k)fluoranthene, Indeno(1,2,3-cd)pyrene, Total 4 PAHs, HCB, PCP, SCCP				
Not estimated	NMVOC, SOx, NH3, PM2.5				
Pollutant	Value	Unit	95% confidence interval		Reference
			Lower	Upper	
NOx	1	kg/ton NH3	0.05	334	IPPC BREF LVIC AAF
CO	0.1	kg/ton NH3	0.001	0.2	IPPC BREF LVIC AAF

3.3.2.2 Nitric acid production (source category 2.B.2)

The following tables contain emission factors for NO_x based on literature data. NO_x emission factors vary considerably depending on the type of control equipment and the process conditions.

Plants for the production of nitric acid can be designed as low pressure (<1.7 bar), medium pressure (1.7–6.5 bar) and high pressure (>8 bar) plants. New plants are only built for pressure ranges above 4 bar.

Table 3.8 Tier 2 emission factor for source category 2.B.2 Nitric acid production, low pressure process, no abatement

Tier 2 emission factors					
NFR Source Category	Code	Name			
	2.B.2	Nitric acid production			
Fuel	NA				
SNAP (if applicable)	040402	Nitric acid			
Technologies/Practices	Low Pressure process				
Region or regional conditions					
Abatement technologies					
Not applicable	CO, NMVOC, SO _x , TSP, PM ₁₀ , Pb, Cd, Hg, As, Cr, Cu, Ni, Se, Zn, Aldrin, Chlordane, Chlordecone, Dieldrin, Endrin, Heptachlor, Heptabromo-biphenyl, Mirex, Toxaphene, HCH, DDT, PCB, PCDD/F, Benzo(a)pyrene, Benzo(b)fluoranthene, Benzo(k)fluoranthene, Indeno(1,2,3-cd)pyrene, Total 4 PAHs, HCB, PCP, SCCP				
Not estimated	NH ₃ , PM _{2.5}				
Pollutant	Value	Unit	95% confidence interval		Reference
			Lower	Upper	
NO _x	12000	g/Mg (100% Acid)	10000	20000	CITEPA (1992)

Table 3.9 Tier 2 emission factor for source category 2.B.2 Nitric acid production, low pressure process, no abatement

Tier 2 emission factors					
NFR Source Category	Code	Name			
	2.B.2	Nitric acid production			
Fuel	NA				
SNAP (if applicable)	040402	Nitric acid			
Technologies/Practices	Low Pressure process				
Region or regional conditions					
Abatement technologies					
Not applicable	CO, NMVOC, SO _x , TSP, PM ₁₀ , Pb, Cd, Hg, As, Cr, Cu, Ni, Se, Zn, Aldrin, Chlordane, Chlordecone, Dieldrin, Endrin, Heptachlor, Heptabromo-biphenyl, Mirex, Toxaphene, HCH, DDT, PCB, PCDD/F, Benzo(a)pyrene, Benzo(b)fluoranthene, Benzo(k)fluoranthene, Indeno(1,2,3-cd)pyrene, Total 4 PAHs, HCB, PCP, SCCP				
Not estimated	NH ₃ , PM _{2.5}				
Pollutant	Value	Unit	95% confidence interval		Reference
			Lower	Upper	
NO _x	3500	g/Mg (100% Acid)	2000	8600	CITEPA (1992)

Table 3.10 Tier 2 emission factors for source category 2.B.2 Nitric acid production, medium pressure process

Tier 2 emission factors					
NFR Source Category	Code	Name			
	2.B.2	Nitric acid production			
Fuel	NA				
SNAP (if applicable)	040402	Nitric acid			
Technologies/Practices	Medium Pressure process				
Region or regional conditions					
Abatement technologies					
Not applicable	CO, NMVOC, SO _x , TSP, PM ₁₀ , Pb, Cd, Hg, As, Cr, Cu, Ni, Se, Zn, Aldrin, Chlordane, Chlordecone, Dieldrin, Endrin, Heptachlor, Heptabromo-biphenyl, Mirex, Toxaphene, HCH, DDT, PCB, PCDD/F, Benzo(a)pyrene, Benzo(b)fluoranthene, Benzo(k)fluoranthene, Indeno(1,2,3-cd)pyrene, Total 4 PAHs, HCB, PCP, SCCP				
Not estimated	NH ₃ , PM _{2.5}				
Pollutant	Value	Unit	95% confidence interval		Reference
			Lower	Upper	
NO _x	7500	g/Mg (100% Acid)	5000	12000	CITEPA (1992)

Table 3.11 Tier 2 emission factors for source category 2.B.2 Nitric acid production, high pressure process

Tier 2 emission factors					
NFR Source Category	Code	Name			
	2.B.2	Nitric acid production			
Fuel	NA				
SNAP (if applicable)	040402	Nitric acid			
Technologies/Practices	High pressure process				
Region or regional conditions					
Abatement technologies					
Not applicable	CO, NMVOC, SOx, TSP, PM10, Pb, Cd, Hg, As, Cr, Cu, Ni, Se, Zn, Aldrin, Chlordane, Chlordecone, Dieldrin, Endrin, Heptachlor, Heptabromo-biphenyl, Mirex, Toxaphene, HCH, DDT, PCB, PCDD/F, Benzo(a)pyrene, Benzo(b)fluoranthene, Benzo(k)fluoranthene, Indeno(1,2,3-cd)pyrene, Total 4 PAHs, HCB, PCP, SCCP				
Not estimated	NH3, PM2.5				
Pollutant	Value	Unit	95% confidence interval		Reference
			Lower	Upper	
NOx	3000	g/Mg (100% Acid)	1500	5000	CITEPA (1992)

Table 3.12 Tier 2 emission factors for source category 2.B.2 Nitric acid production, direct strong acid process

Tier 2 emission factors					
NFR Source Category	Code	Name			
	2.B.2	Nitric acid production			
Fuel	NA				
SNAP (if applicable)	040402	Nitric acid			
Technologies/Practices	Direct strong acid process				
Region or regional conditions					
Abatement technologies					
Not applicable	CO, NMVOC, SOx, TSP, PM10, Pb, Cd, Hg, As, Cr, Cu, Ni, Se, Zn, Aldrin, Chlordane, Chlordecone, Dieldrin, Endrin, Heptachlor, Heptabromo-biphenyl, Mirex, Toxaphene, HCH, DDT, PCB, PCDD/F, Benzo(a)pyrene, Benzo(b)fluoranthene, Benzo(k)fluoranthene, Indeno(1,2,3-cd)pyrene, Total 4 PAHs, HCB, PCP, SCCP				
Not estimated	NH3, PM2.5				
Pollutant	Value	Unit	95% confidence interval		Reference
			Lower	Upper	
NOx	500	g/Mg (100% Acid)	100	1000	CITEPA (1992)

Catalytic purification can be divided into a non-selective and a selective process. Both processes for waste gas treatment require a minimum temperature and a minimum pressure, conditions that often cannot be achieved in old plants.

In non-selective reduction processes, the waste gas reacts with a reduction agent (hydrogen and/or hydrocarbons e.g. natural gas, waste gas from ammonia plants or naphtha) by passing a catalyst (which contains platinum, rhodium or palladium). Depending on the reduction conditions (amount of reduction agent) the reduction product is either nitrogen monoxide or nitrogen. The use of hydrocarbons has the disadvantage that the waste gas contains carbon monoxide as well as hydrocarbons in a non-converted or partially converted state.

In the selective reduction process the reduction agent, ammonia, reacts with nitric oxides to form nitrogen and water. The catalysts used are, for example, vanadium pentoxide, platinum, iron/chromium oxides mixtures or zeolites. According to the stoichiometric conditions of the reaction, an excess of ammonia is necessary. This process can offer economic advantages for plants with small capacities (less than 100 t of N per day).

Table 3.13 Tier 2 emission factors for source category 2.B.2 Nitric acid production, low, medium and high pressure process, catalytic reduction

Tier 2 emission factors					
NFR Source Category	Code	Name			
	2.B.2	Nitric acid production			
Fuel	NA				
SNAP (if applicable)	040402	Nitric acid			
Technologies/Practices	Low, medium and high pressure processes				
Region or regional conditions					
Abatement technologies	Catalytic Reduction				
Not applicable	CO, NMVOC, SOx, TSP, PM10, Pb, Cd, Hg, As, Cr, Cu, Ni, Se, Zn, Aldrin, Chlordane, Chlordecone, Dieldrin, Endrin, Heptachlor, Heptabromo-biphenyl, Mirex, Toxaphene, HCH, DDT, PCB, PCDD/F, Benzo(a)pyrene, Benzo(b)fluoranthene, Benzo(k)fluoranthene, Indeno(1,2,3-cd)pyrene, Total 4 PAHs, HCB, PCP, SCCP				
Not estimated	NH3, PM2.5				
Pollutant	Value	Unit	95% confidence interval		Reference
			Lower	Upper	
NOx	400	g/Mg (100% Acid)	10	800	Guidebook (2006)

Extended absorption reduces nitrogen oxide emissions by treatment of the waste gas either with sodium hydroxide or with ammonia. By treating the waste gas with sodium hydroxide, NO and NO₂ are absorbed and sodium nitrite (NaNO₂) is formed. Under certain conditions a NO_x content in the waste gas of 200 ppm by volume can be achieved (absorption pressure of more than 4.5 bar, NO_x content by volume of less than 600 ppm etc.).

Table 3.14 Tier 2 emission factors for source category 2.B.2 Nitric acid production, low, medium and high pressure process, extended absorption

Tier 2 emission factors					
NFR Source Category	Code	Name			
	2.B.2	Nitric acid production			
Fuel	NA				
SNAP (if applicable)	040402	Nitric acid			
Technologies/Practices	Low, medium and high pressure processes				
Region or regional conditions					
Abatement technologies	Extended absorption				
Not applicable	CO, NMVOC, SOx, TSP, PM10, Pb, Cd, Hg, As, Cr, Cu, Ni, Se, Zn, Aldrin, Chlordane, Chlordecone, Dieldrin, Endrin, Heptachlor, Heptabromo-biphenyl, Mirex, Toxaphene, HCH, DDT, PCB, PCDD/F, Benzo(a)pyrene, Benzo(b)fluoranthene, Benzo(k)fluoranthene, Indeno(1,2,3-cd)pyrene, Total 4 PAHs, HCB, PCP, SCCP				
Not estimated	NH3, PM2.5				
Pollutant	Value	Unit	95% confidence interval		Reference
			Lower	Upper	
NOx	900	g/Mg (100% Acid)	400	1400	Guidebook (2006)

3.3.2.3 Adipic acid production (source category 2.B.3)

Adipic acid production is relevant for emissions of greenhouse gasses (N₂O) and although emission factors are listed below, it is not considered a key category for other air emissions included in the protocols.

Table 3.15 Tier 2 emission factors for source category 2.B.3 Adipic acid production

Tier 2 emission factors					
	Code	Name			
NFR Source Category	2.B.3	Adipic acid production			
Fuel	NA				
SNAP (if applicable)					
Technologies/Practices					
Region or regional conditions					
Abatement technologies					
Not applicable	NMVOC, SO _x , NH ₃ , TSP, PM ₁₀ , Pb, Cd, Hg, As, Cr, Cu, Ni, Se, Zn, Aldrin, Chlordane, Chlordecone, Dieldrin, Endrin, Heptachlor, Heptabromo-biphenyl, Mirex, Toxaphene, HCH, DDT, PCB, PCDD/F, Benzo(a)pyrene, Benzo(b)fluoranthene, Benzo(k)fluoranthene, Indeno(1,2,3-cd)pyrene, Total 4 PAHs, HCB, PCP, SCCP				
Not estimated	PM _{2.5}				
Pollutant	Value	Unit	95% confidence interval		Reference
			Lower	Upper	
NO _x	8	kg/Mg	4	16	US EPA AP42
CO	0.4	kg/Mg	0.2	0.8	US EPA AP42

3.3.2.4 Calcium carbide production (source category 2.B.4)

Emissions of dust can be encountered at various stages over the whole production process. The main source of dust emissions is dust-laden furnace gas. Diffuse emissions arising from the tapping of liquid CaC₂ can be significantly reduced by a fume extraction system and waste gas treatment. Further dust emission sources are handling of raw materials, tapping off liquid calcium carbide in the furnace and post-processing the produced calcium carbide until it is stored.

Table 3.16 Tier 2 emission factors for source category 2.B.4 Calcium carbide production

Tier 2 emission factors					
	Code	Name			
NFR Source Category	2.B.4	Carbide production			
Fuel	NA				
SNAP (if applicable)					
Technologies/Practices	CaC ₂ production without the usage of furnace gas				
Region or regional conditions					
Abatement technologies	various, dedusting				
Not applicable	NH ₃ , Aldrin, Chlordane, Chlordecone, Dieldrin, Endrin, Heptachlor, Heptabromo-biphenyl, Mirex, Toxaphene, HCH, DDT, PCB, PCP, SCCP				
Not estimated	NO _x , CO, NMVOC, SO _x , PM ₁₀ , PM _{2.5} , Pb, Cd, Hg, As, Cr, Cu, Ni, Se, Zn, PCDD/F, Benzo(a)pyrene, Benzo(b)fluoranthene, Benzo(k)fluoranthene, Indeno(1,2,3-cd)pyrene, Total 4				
Pollutant	Value	Unit	95% confidence interval		Reference
			Lower	Upper	
TSP	49	g/Mg produced	20	100	IPPC BREF LVIC SAO

Table 3.17 Tier 2 emission factors for source category 2.B.4 Calcium carbide production

Tier 2 emission factors					
	Code	Name			
NFR Source Category	2.B.4	Carbide production			
Fuel	NA				
SNAP (if applicable)					
Technologies/Practices	CaC ₂ production with the usage of furnace gas (e.g. lime kiln)				
Region or regional conditions					
Abatement technologies	Venturi scrubber				
Not applicable	NH ₃ , Aldrin, Chlordane, Chlordecone, Dieldrin, Endrin, Heptachlor, Heptabromo-biphenyl, Mirex, Toxaphene, HCH, DDT, PCB, PCP, SCCP				
Not estimated	NO _x , CO, NMVOC, SO _x , PM ₁₀ , PM _{2.5} , Pb, Cd, Hg, As, Cr, Cu, Ni, Se, Zn, PCDD/F, Benzo(a)pyrene, Benzo(b)fluoranthene, Benzo(k)fluoranthene, Indeno(1,2,3-cd)pyrene, Total 4				
Pollutant	Value	Unit	95% confidence interval		Reference
			Lower	Upper	
TSP	80.9	g/Mg produced	40	160	IPPC BREF LVIC SAO (2006)

3.3.2.5 Other chemical industry (source category 2.B.5.a)

Tier 2 emission factors for the chemical processes under source category 2.B.5.a Other chemical industry are presented below.

Sulphuric acid (040401)

This sub-section provides emission factors for a number of different processes for the production of sulphur dioxide.

The following tables contain Tier 2 emission factors for the relevant pollutants SO₂ and SO₃ based on literature data. Emissions are expressed with reference to different compounds. Emission factor are given in relation to SO_x.

Table 3.18 Tier 2 emission factors for source category 2.B.5.a Other chemical industry, sulphuric acid production, contact process without inter-mediate absorption (single absorption)

Tier 2 emission factors					
	Code	Name			
NFR Source Category	2.B.5.a	Other chemical industry (Please specify the sources included/excluded in the notes)			
Fuel	NA				
SNAP (if applicable)	040401	Sulfuric acid			
Technologies/Practices	Contact process without inter-mediate absorption (single absorption)				
Region or regional conditions					
Abatement technologies					
Not applicable					
Not estimated	NOx, CO, NMVOC, NH3, TSP, PM10, PM2.5, Pb, Cd, Hg, As, Cr, Cu, Ni, Se, Zn, Aldrin, Chlordane, Chlordecone, Dieldrin, Endrin, Heptachlor, Heptabromo-biphenyl, Mirex, Toxaphene, HCH, DDT, PCB, PCDD/F, Benzo(a)pyrene, Benzo(b)fluoranthene, Benzo(k)fluoranthene, Indeno(1,2,3-cd)pyrene, Total 4 PAHs, HCB, PCP, SCCP				
Pollutant	Value	Unit	95% confidence interval		Reference
			Lower	Upper	
SOx	9050	g/Mg (100% H2SO4)	1100	17000	Bol (1993)

Table 3.19 Tier 2 emission factors for source category 2.B.5.a Other chemical industry, sulphuric acid production, contact process with inter-mediate absorption (double absorption)

Tier 2 emission factors					
	Code	Name			
NFR Source Category	2.B.5.a	Other chemical industry (Please specify the sources included/excluded in the notes)			
Fuel	NA				
SNAP (if applicable)	040401	Sulfuric acid			
Technologies/Practices	Contact process with inter-mediate absorption (double absorption)				
Region or regional conditions					
Abatement technologies					
Not applicable					
Not estimated	NOx, CO, NMVOC, NH3, TSP, PM10, PM2.5, Pb, Cd, Hg, As, Cr, Cu, Ni, Se, Zn, Aldrin, Chlordane, Chlordecone, Dieldrin, Endrin, Heptachlor, Heptabromo-biphenyl, Mirex, Toxaphene, HCH, DDT, PCB, PCDD/F, Benzo(a)pyrene, Benzo(b)fluoranthene, Benzo(k)fluoranthene, Indeno(1,2,3-cd)pyrene, Total 4 PAHs, HCB, PCP, SCCP				
Pollutant	Value	Unit	95% confidence interval		Reference
			Lower	Upper	
SOx	3000	g/Mg (100% H2SO4)	1000	5000	CITEPA (1992)

Table 3.20 Tier 2 emission factors for source category 2.B.5.a Other chemical industry, sulphuric acid production, contact process with inter-mediate absorption (double absorption, decomposition plants, spent sulphuric acid)

Tier 2 emission factors					
	Code	Name			
NFR Source Category	2.B.5.a	Other chemical industry (Please specify the sources included/excluded in the notes)			
Fuel	NA				
SNAP (if applicable)	040401	Sulfuric acid			
Technologies/Practices	Contact process with inter-mediate absorption (double absorption)				
Region or regional conditions					
Abatement technologies					
Not applicable					
Not estimated	NOx, CO, NMVOC, SOx, NH3, TSP, PM10, PM2.5, Pb, Cd, Hg, As, Cr, Cu, Ni, Se, Zn, Aldrin, Chlordane, Chlordecone, Dieldrin, Endrin, Heptachlor, Heptabromo-biphenyl, Mirex, Toxaphene, HCH, DDT, PCB, PCDD/F, Benzo(a)pyrene, Benzo(b)fluoranthene, Benzo(k)fluoranthene, Indeno(1,2,3-cd)pyrene, Total 4 PAHs, HCB, PCP, SCCP				
Pollutant	Value	Unit	95% confidence interval		Reference
			Lower	Upper	
SOx	7000	g/Mg (100% H2SO4)	3000	10000	Guidebook (2006)

Table 3.21 Tier 2 emission factors for source category 2.B.5.a Other chemical industry, sulphuric acid production, wet contact process (98% and 78 % sulphuric acid)

Tier 2 emission factors					
	Code	Name			
NFR Source Category	2.B.5.a	Other chemical industry (Please specify the sources included/excluded in the notes)			
Fuel	NA				
SNAP (if applicable)	040401	Sulfuric acid			
Technologies/Practices	Wet contact process (98% and 78 % sulphuric acid)				
Region or regional conditions					
Abatement technologies					
Not applicable					
Not estimated	NOx, CO, NMVOC, SOx, NH3, TSP, PM10, PM2.5, Pb, Cd, Hg, As, Cr, Cu, Ni, Se, Zn, Aldrin, Chlordane, Chlordecone, Dieldrin, Endrin, Heptachlor, Heptabromo-biphenyl, Mirex, Toxaphene, HCH, DDT, PCB, PCDD/F, Benzo(a)pyrene, Benzo(b)fluoranthene, Benzo(k)fluoranthene, Indeno(1,2,3-cd)pyrene, Total 4 PAHs, HCB, PCP, SCCP				
Pollutant	Value	Unit	95% confidence interval		Reference
			Lower	Upper	
SOx	17000	g/Mg (100% H2SO4)	15000	20000	Guidebook (2006)

Table 3.22 Tier 2 emission factors for source category 2.B.5.a Other chemical industry, sulphuric acid production, wet/dry contact process with intermediate condensation/ absorption

Tier 2 emission factors					
	Code	Name			
NFR Source Category	2.B.5.a	Other chemical industry (Please specify the sources included/excluded in the notes)			
Fuel	NA				
SNAP (if applicable)	040401	Sulfuric acid			
Technologies/Practices	Wet/dry contact process with intermediate condensation/ absorption				
Region or regional conditions					
Abatement technologies					
Not applicable					
Not estimated	NOx, CO, NMVOC, SOx, NH3, TSP, PM10, PM2.5, Pb, Cd, Hg, As, Cr, Cu, Ni, Se, Zn, Aldrin, Chlordane, Chlordecone, Dieldrin, Endrin, Heptachlor, Heptabromo-biphenyl, Mirex, Toxaphene, HCH, DDT, PCB, PCDD/F, Benzo(a)pyrene, Benzo(b)fluoranthene, Benzo(k)fluoranthene, Indeno(1,2,3-cd)pyrene, Total 4 PAHs, HCB, PCP, SCCP				
Pollutant	Value	Unit	95% confidence interval		Reference
			Lower	Upper	
SOx	3500	g/Mg (100% H2SO4)	2500	4500	Guidebook (2006)

Ammonium sulphate (040404)

Ammonium sulphate is produced as a caprolactam by-product from the petrochemical industry, as a coke by-product and synthetically through reaction of ammonia with sulphuric acid. The reaction between ammonia and sulphuric acid produces an ammonium sulphate solution that is continuously circulated through an evaporator to thicken the solution and to produce ammonium sulphate crystals. The crystals are separated from the liquor in a centrifuge and the liquor is returned to the evaporator. The crystals are fed either to a fluidised bed or to a rotary drum dryer and are screened before bagging or bulk loading.

Particulate matter is the principal air pollutant emitted from ammonium sulphate plants. Most of the particulates are found in the gaseous exhaust of the dryers. Uncontrolled discharges of particulates may be of the order of 23 kg/t from rotary dryers and 109 kg/t from fluidised bed dryers. Ammonia storage tanks can release ammonia and there may be fugitive losses of ammonia from process equipment.

Table 3.23 Tier 2 emission factors for source category 2.B.5.a Other chemical industry, ammonium sulphate (040404)

Tier 2 emission factors					
	Code	Name			
NFR Source Category	2.B.5.a	Other chemical industry (Please specify the sources included/excluded in the notes)			
Fuel	NA				
SNAP (if applicable)	040404	Ammonium sulphate			
Technologies/Practices					
Region or regional conditions					
Abatement technologies	uncontrolled				
Not applicable					
Not estimated		NO _x , CO, NMVOC, SO _x , NH ₃ , PM ₁₀ , PM _{2.5} , Pb, Cd, Hg, As, Cr, Cu, Ni, Se, Zn, Aldrin, Chlordane, Chlordecone, Dieldrin, Endrin, Heptachlor, Heptabromo-biphenyl, Mirex, Toxaphene, HCH, DDT, PCB, PCDD/F, Benzo(a)pyrene, Benzo(b)fluoranthene, Benzo(k)fluoranthene, Indeno(1,2,3-cd)pyrene, Total 4 PAHs, HCB, PCP, SCCP			
Pollutant	Value	Unit	95% confidence interval		Reference
			Lower	Upper	
TSP	60	kg/ton	23	109	US EPA AP42

Ammonium nitrate (040405)

Ammonium nitrate is made by neutralising nitric acid with anhydrous ammonia. The resulting 80–90 % solution of ammonium nitrate can be sold in that state or it may be further concentrated to a 95–99.5% solution (melt) and converted into prills or granules. The manufacturing steps include solution formation, solution concentration, solids formation, solids finishing, screening, coating, and bagging or bulk shipping. The processing steps depend on the desired finished product.

The production of ammonium nitrate yields emissions of particulate matter (ammonium nitrate and coating materials), ammonia, and nitric acid. The emission sources of primary importance are the prilling tower and the granulator. Total quantities of nitrogen discharged are in the range of 0.01–18.4 kg/t of product. Values reported for calcium ammonium nitrate are in the range of 0.13–3 kg nitrogen per tonne of product.

Table 3.24 Tier 2 emission factors for source category 2.B.5.a Other chemical industry, ammonium nitrate (040405)

Tier 2 emission factors					
NFR Source Category	Code	Name			
Fuel	2.B.5.a	Other chemical industry (Please specify the sources included/excluded in the notes)			
SNAP (if applicable)	NA				
Technologies/Practices	040405	Ammonium nitrate			
Region or regional conditions					
Abatement technologies	uncontrolled				
Not applicable					
Not estimated	NOx, CO, NMVOC, SOx, PM10, PM2.5, Pb, Cd, Hg, As, Cr, Cu, Ni, Se, Zn, Aldrin, Chlordane, Chlordecone, Dieldrin, Endrin, Heptachlor, Heptabromo-biphenyl, Mirex, Toxaphene, HCH, DDT, PCB, PCDD/F, Benzo(a)pyrene, Benzo(b)fluoranthene, Benzo(k)fluoranthene, Indeno(1,2,3-cd)pyrene, Total 4 PAHs, HCB, PCP, SCCP				
Pollutant	Value	Unit	95% confidence interval		Reference
			Lower	Upper	
NH3	30	kg/ton	0.1	40	US EPA AP42
TSP	200	kg/ton	20	400	US EPA AP42

Ammonium phosphate (040406) en NPK fertilisers (040407)

Mixed fertilisers contain two or more of the elements nitrogen, phosphorus, and potassium (NPK).

Ammonium phosphates are produced by mixing phosphoric acid and anhydrous ammonia in a reactor to produce slurry. This is referred to as the mixed acid route for producing NPK fertilisers; potassium and other salts are added during the process. The slurry is sprayed onto a bed of recycled solids in a rotating granulator, and ammonia is sparged into the bed from underneath. Granules pass to a rotary dryer followed by a rotary cooler. Solids are screened and sent to storage for bagging or for bulk shipment.

Nitrophosphate fertiliser is made by digesting phosphate rock with nitric acid. This is the nitrophosphate route leading to NPK fertilisers; as in the mixed-acid route, potassium and other salts are added during the process. The resulting solution is cooled to precipitate calcium nitrate, which is removed by filtration methods. The filtrate is neutralised with ammonia, and the solution is evaporated to reduce the water content. The process of prilling may follow. The calcium nitrate filter cake can be further treated to produce a calcium nitrate fertiliser, pure calcium nitrate, or ammonium nitrate and calcium carbonate.

Materials handling and milling of phosphate rock should be carried out in closed buildings. Fugitive emissions can be controlled by, for example, hoods on conveying equipment, with capture of the dust in fabric filters. In the ammonium phosphate plant, the gas streams from the reactor, granulator, dryer and cooler should be passed through cyclones and scrubbers, using phosphoric acid as the scrubbing liquid, to recover particulates, ammonia, and other materials for recycling. In the nitrophosphate plant, nitrogen oxide (NO) emissions should be avoided by adding urea to the digestion stage. Fluoride emissions should be prevented by scrubbing the gases with water. Ammonia should be removed by scrubbing. Phosphoric acid may be used for scrubbing where the ammonia load is high. The process water system should be balanced, if necessary, by the use of holding tanks to avoid the discharge of an effluent.

Additional pollution control devices beyond the scrubbers, cyclones and baghouses that are an integral part of the plant design and operations are generally not required for mixed fertiliser plants. Air emissions at point of discharge should be monitored continuously for fluorides and particulates and annually for ammonia and nitrogen oxides. Monitoring data should be analysed and reviewed at regular intervals and compared with the operating standards so that any necessary

corrective actions can be taken. Records of monitoring results should be kept in an acceptable format. The results should be reported to the responsible authorities and relevant parties, as required. The key production and control practices that will lead to compliance with emissions requirements can be summarised as follows: maximise product recovery and minimise air emissions by appropriate maintenance and operation of scrubbers and baghouses. Prepare and implement an emergency preparedness and response plan. Such a plan is required because of the large quantities of ammonia and other hazardous materials stored and handled on site. (Cheremisinoff, 2002)

Table 3.25 Tier 2 emission factors for source category 2.B.5.a Other chemical industry, ammonium phosphate (040406)

Tier 2 emission factors					
	Code	Name			
NFR Source Category	2.B.5.a	Other chemical industry (Please specify the sources included/excluded in the notes)			
Fuel	NA				
SNAP (if applicable)	040406	Ammonium phosphate			
Technologies/Practices					
Region or regional conditions					
Abatement technologies					
Not applicable					
Not estimated	NOx, CO, NMVOC, SOx, NH ₃ , Pb, Cd, Hg, As, Cr, Cu, Ni, Se, Zn, Aldrin, Chlordane, Chlordecone, Dieldrin, Endrin, Heptachlor, Heptabromo-biphenyl, Mirex, Toxaphene, HCH, DDT, PCB, PCDD/F, Benzo(a)pyrene, Benzo(b)fluoranthene, Benzo(k)fluoranthene, Indeno(1,2,3-cd)pyrene, Total 4 PAHs, HCB, PCP, SCCP				
Pollutant	Value	Unit	95% confidence interval		Reference
			Lower	Upper	
TSP	300	g/ton	150	600	Visschedijk et al. (2004)
PM10	240	g/ton	120	480	Visschedijk et al. (2004)
PM2.5	180	g/ton	90	360	Visschedijk et al. (2004)

Urea (040408)

Urea is produced commercially from synthetic ammonia and carbon dioxide.

In a urea plant, ammonia and particulate matter are the emissions of concern. Ammonia emissions are reported as recovery absorption vent (0.1–0.5 kg/t), concentration absorption vent (0.1–0.2 kg/t), urea prilling (0.5–2.2 kg/t) and granulation (0.2–0.7 kg/t). The prill tower is a source of urea dust (0.5–2.2 kg/t), as is the granulator (0.1–0.5 kg/t) (EPA, 1993).

Table 3.26 Tier 2 emission factors for source category 2.B.5.a Other chemical industry, urea (040408)

Tier 2 emission factors					
	Code	Name			
NFR Source Category	2.B.5.a	Other chemical industry (Please specify the sources included/excluded in the notes)			
Fuel	NA				
SNAP (if applicable)	040408	Urea			
Technologies/Practices					
Region or regional conditions					
Abatement technologies					
Not applicable					
Not estimated	NOx, CO, NMVOC, SOx, Pb, Cd, Hg, As, Cr, Cu, Ni, Se, Zn, Aldrin, Chlordane, Chlordecone, Dieldrin, Endrin, Heptachlor, Heptabromo-biphenyl, Mirex, Toxaphene, HCH, DDT, PCB, PCDD/F, Benzo(a)pyrene, Benzo(b)fluoranthene, Benzo(k)fluoranthene, Indeno(1,2,3-cd)pyrene, Total 4 PAHs, HCB, PCP, SCCP				
Pollutant	Value	Unit	95% confidence interval		Reference
			Lower	Upper	
NH ₃	2.5	kg/Mg	1	5	US EPA AP42
TSP	1.5	kg/Mg	0.7	3	US EPA AP42
PM10	1.2	kg/Mg	0.6	2.4	US EPA AP42
PM2.5	0.9	kg/Mg	0.4	1.8	US EPA AP42

Carbon black (040409)

Carbon black is a form of highly dispersed elemental carbon with extremely small particles. Depending on the raw materials and production processes, carbon black also contains chemically bound hydrogen, oxygen, nitrogen, and sulphur.

The most important process today is the 'furnace black process', a continuous process, which allows the production of a variety of carbon black grades under carefully controlled conditions. Mixtures of gaseous or liquid hydrocarbons, which can be vaporised, represent the raw feedstock preferable for the industrial production of carbon black. The heart of a furnace black plant is the furnace in which the carbon black is formed. The primary feedstock is injected, usually as an atomised spray, into a high temperature zone of high energy density, which is achieved by burning a secondary feedstock (natural gas or oil) with air. The oxygen, which is in excess with respect to the secondary feedstock, is not sufficient for complete combustion of the primary feedstock, the majority of which is, therefore, pyrolysed to form carbon black at 1200–1900 °C.

The reaction mixture is then quenched with water and further cooled in heat exchangers, and the carbon black is collected from the tail-gas by a filter system. In the furnace black process, distinction can be made between the venting of non-combusted tail-gas,⁽⁷⁾ the emissions from tail-gas combustion devices (flares, boilers, incinerators), emissions from the tail-gas fired product dryers and the filter system vents (EC, 2006c). The process can be considered as a process with contact, since feedstock is injected in the thermal zone of burning a secondary feedstock. Emission factors are therefore also include emissions from combustion.

Emission sources of particulate matter are:

- slip through filter system behind reactor;
- slip through dedusting filter systems, e.g. behind dryer;
- slip through thermal combustor (e.g. boiler, flare);
- fugitive emissions due to storage, transportation and packaging

Emissions of other components are caused by incomplete combustion in the reactor and incomplete combustion in dryers, boilers, flares, etc.

⁽⁷⁾ Tail-gas comes from the reactor after product separation and is a low calorific gas with high moisture content due to the quench water vapour. It contains hydrogen (H₂), carbon oxides (CO and CO₂), reduced sulphur compounds (H₂S, CS₂ and COS), sulphur dioxide (SO₂), nitrogen compounds (N₂, NOX, HCN and NH₃) and volatile organic compounds, such as ethane and acetylene.

Table 3.27 Tier 2 emission factors for source category 2.B.5.a Other chemical industry, carbon black production

Tier 2 emission factors					
NFR Source Category	Code	Name			
	2.B.5.a	Other chemical industry (Please specify the sources included/excluded in the notes)			
Fuel	NA				
SNAP (if applicable)	040409	Carbon black			
Technologies/Practices	Furnace black process (conventional process)				
Region or regional conditions					
Abatement technologies					
Not applicable					
Not estimated	NH ₃ , PM ₁₀ , PM _{2.5} , Pb, Cd, Hg, As, Cr, Cu, Ni, Se, Zn, Aldrin, Chlordane, Chlordecone, Dieldrin, Endrin, Heptachlor, Heptabromo-biphenyl, Mirex, Toxaphene, HCH, DDT, PCB, PCDD/F, Benzo(a)pyrene, Benzo(b)fluoranthene, Benzo(k)fluoranthene, Indeno(1,2,3-cd)pyrene, Total 4 PAHs, HCB, PCP, SCCP				
Pollutant	Value	Unit	95% confidence interval		Reference
			Lower	Upper	
NO _x	15	kg/tonne carbon black	6	15	IPPC BREF, LVIC SAO (2006)
CO	3	kg/tonne carbon black	2	3	IPPC BREF, LVIC SAO (2006)
NM VOC	0.7	kg/tonne carbon black	0	0.7	IPPC BREF, LVIC SAO (2006)
SO _x	22	kg/tonne carbon black	6.5	22	IPPC BREF, LVIC SAO (2006)
TSP	0.3	kg/tonne carbon black	0.2	0.4	IPPC BREF, LVIC SAO (2006)

The range for sulphur content in feedstock is 0.3–1.0 wt.% S. Actual permitted levels are higher than 1 % S for most European plants and significantly higher for all plants in the USA (EC, 2006c).

Titanium dioxide (040410)

Titanium dioxide (TiO₂) pigments are made from one of two chemical processes: the chloride route, which leads to TiO₂ products by reacting titanium ores with chlorine gas; and the sulphate route, which leads to TiO₂ products by reacting titanium ores with sulphuric acid. In both processes pure titanium dioxide powder is extracted from its mineral feedstock after which it is milled and treated to produce a range of products designed to be suitable for efficient incorporation into different substrates as described above.

Table 3.28 Tier 2 emission factors for source category 2.B.5.a Other chemical industry, titanium dioxide production, chloride process

Tier 2 emission factors					
NFR Source Category	Code	Name			
	2.B.5.a	Other chemical industry (Please specify the sources included/excluded in the notes)			
Fuel	NA				
SNAP (if applicable)	040410	Titanium dioxide			
Technologies/Practices	Chloride process				
Region or regional conditions					
Abatement technologies					
Not applicable					
Not estimated	NMVOC, NH ₃ , PM ₁₀ , PM _{2.5} , Pb, Cd, Hg, As, Cr, Cu, Ni, Se, Zn, Aldrin, Chlordane, Chlordecone, Dieldrin, Endrin, Heptachlor, Heptabromo-biphenyl, Mirex, Toxaphene, HCH, DDT, PCB, PCDD/F, Benzo(a)pyrene, Benzo(b)fluoranthene, Benzo(k)fluoranthene, Indeno(1,2,3-cd)pyrene, Total 4 PAHs, HCB, PCP, SCCP				
Pollutant	Value	Unit	95% confidence interval		Reference
			Lower	Upper	
NO _x	0.1	kg/ton	0.05	0.2	IPPC BREF, LVIC SAO (2006)
CO	159	kg/ton	80	300	IPPC BREF, LVIC SAO (2006)
SO _x	1.14	kg/ton	0.5	2	IPPC BREF, LVIC SAO (2006)
TSP	0.2	kg/ton	0.1	0.3	IPPC BREF, LVIC SAO (2006)

Table 3.29 Tier 2 emission factors for source category 2.B.5.a Other chemical industry, titanium dioxide production, sulphate process

Tier 2 emission factors					
	Code	Name			
NFR Source Category	2.B.5.a	Other chemical industry (Please specify the sources included/excluded in the notes)			
Fuel	NA				
SNAP (if applicable)	040410	Titanium dioxide			
Technologies/Practices	Sulphate process				
Region or regional conditions					
Abatement technologies					
Not applicable					
Not estimated	CO, NMVOC, NH ₃ , PM ₁₀ , PM _{2.5} , Pb, Cd, Hg, As, Cr, Cu, Ni, Se, Zn, Aldrin, Chlordane, Chlordecone, Dieldrin, Endrin, Heptachlor, Heptabromo-biphenyl, Mirex, Toxaphene, HCH, DDT, PCB, PCDD/F, Benzo(a)pyrene, Benzo(b)fluoranthene, Benzo(k)fluoranthene, Indeno(1,2,3-cd)pyrene, Total 4 PAHs, HCB, PCP, SCCP				
Pollutant	Value	Unit	95% confidence interval		Reference
			Lower	Upper	
NO _x	0.108	kg/ton	0.05	0.2	IPPC BREF, LVIC SAO (2006)
SO _x	3.97	kg/ton	2	8	IPPC BREF, LVIC SAO (2006)
TSP	0.3	kg/ton	0.004	0.45	IPPC BREF, LVIC SAO (2006)

Graphite (040411)

Coke or carbon is usually bound with pitch (14–18 % by weight) to produce a green paste. This paste then undergoes a number of shaping, baking, impregnation and graphitising stages to produce the final product. Green paste is also used directly for Söderberg electrodes. The baking process results in a loss in weight of some 5 % of the mass of the material. Packing coke is used in certain furnaces and in these cases is consumed at the rate of approximately 14 kg/t of product. The main environmental impact of these processes is the emission to air of tars and polycyclic aromatic hydrocarbons (PAHs), sulphur dioxide from coke and fuels and NMVOCs from impregnating agents. A variety of new abatement processes have been developed to destroy tars and PAHs using novel afterburning systems. Unfortunately, no emission factors are available for this process.

Table 3.30 Tier 2 emission factors for source category 2.B.5.a Other chemical industry, graphite (040411)

Tier 2 emission factors					
	Code	Name			
NFR Source Category	2.B.5.a	Other chemical industry (Please specify the sources included/excluded in the notes)			
Fuel	NA				
SNAP (if applicable)	040411	Graphite			
Technologies/Practices					
Region or regional conditions					
Abatement technologies					
Not applicable					
Not estimated	NO _x , CO, NMVOC, SO _x , NH ₃ , TSP, PM ₁₀ , PM _{2.5} , Pb, Cd, Hg, As, Cr, Cu, Ni, Se, Zn, Aldrin, Chlordane, Chlordecone, Dieldrin, Endrin, Heptachlor, Heptabromo-biphenyl, Mirex, Toxaphene, HCH, DDT, PCB, PCDD/F, Benzo(a)pyrene, Benzo(b)fluoranthene, Benzo(k)fluoranthene, Indeno(1,2,3-cd)pyrene, Total 4 PAHs, HCB, PCP, SCCP				

Chlorine production (040413)

Chlorine (Cl₂) is produced by electrolysis of a salt solution, together with alkali, sodium, hydroxide (NaOH) or potassium hydroxide (KOH). Because chlorine is a hazardous gas, leakage from electrolytic cells is avoided. However, small amounts of chlorine might be emitted through leakage and handling of the cell covers. Several chlorine detectors are normally placed in the electrolysis hall, giving immediate indication of any significant leakage. Estimated emissions vary

from close to zero to 16 g chlorine per tonne of chlorine produced. The main processes applied for chlor-alkali production are:

- mercury cell;
- diaphragm;
- membrane cell electrolysis, mainly using sodium chloride (NaCl) as feed or to a lesser extent using potassium chloride (KCl) for the production of potassium hydroxide.

Using the mercury cell process, air emissions consist of mercury and, in small quantities, chlorine gas from the cells.

Table 3.31 Tier 2 emission factors for source category 2.B.5.a Other chemical industry, chlorine production, mercury cell (040413)

Tier 2 emission factors					
NFR Source Category	Code	Name			
Fuel	2.B.5.a	Other chemical industry (Please specify the sources included/excluded in the notes)			
SNAP (if applicable)	NA				
Technologies/Practices	040413	Chlorine production			
Region or regional conditions		mercury cell			
Abatement technologies					
Not applicable					
Not estimated		NO _x , CO, NMVOC, SO _x , NH ₃ , TSP, PM ₁₀ , PM _{2.5} , Pb, Cd, As, Cr, Cu, Ni, Se, Zn, Aldrin, Chlordane, Chlordecone, Dieldrin, Endrin, Heptachlor, Heptabromo-biphenyl, Mirex, Toxaphene, HCH, DDT, PCB, PCDD/F, Benzo(a)pyrene, Benzo(b)fluoranthene, Benzo(k)fluoranthene, Indeno(1,2,3-cd)pyrene, Total 4 PAHs, HCB, PCP, SCCP			
Pollutant	Value	Unit	95% confidence interval		Reference
			Lower	Upper	
Hg	4.8	g/Mg	1.9	7.7	Theloke et al. (2008)

Using the diaphragm cell process, air emissions consist of asbestos and fugitive emissions of chlorine from the cells and in the process tail gases. No emission factors are available for the pollutants considered in this Guidebook.

Table 3.32 Tier 2 emission factors for source category 2.B.5.a Other chemical industry, chlorine production, diaphragm cell (040413)

Tier 2 emission factors				
NFR Source Category	Code	Name		
Fuel	2.B.5.a	Other chemical industry (Please specify the sources included/excluded in the notes)		
SNAP (if applicable)	NA			
Technologies/Practices	040413	Chlorine production		
Region or regional conditions		Diaphragm cell process		
Abatement technologies				
Not applicable				
Not estimated		NO _x , CO, NMVOC, SO _x , NH ₃ , TSP, PM ₁₀ , PM _{2.5} , Pb, Cd, Hg, As, Cr, Cu, Ni, Se, Zn, Aldrin, Chlordane, Chlordecone, Dieldrin, Endrin, Heptachlor, Heptabromo-biphenyl, Mirex, Toxaphene, HCH, DDT, PCB, PCDD/F, Benzo(a)pyrene, Benzo(b)fluoranthene, Benzo(k)fluoranthene, Indeno(1,2,3-cd)pyrene, Total 4 PAHs, HCB, PCP, SCCP		

Table 3.33 Tier 2 emission factors for source category 2.B.5.a Other chemical industry, chlorine production, membrane cell (040413)

Tier 2 emission factors		
	Code	Name
NFR Source Category	2.B.5.a	Other chemical industry (Please specify the sources included/excluded in the notes)
Fuel	NA	
SNAP (if applicable)	040413	Chlorine production
Technologies/Practices	Membrane cell process	
Region or regional conditions		
Abatement technologies		
Not applicable		
Not estimated	NOx, CO, NMVOC, SOx, NH3, TSP, PM10, PM2.5, Pb, Cd, Hg, As, Cr, Cu, Ni, Se, Zn, Aldrin, Chlordane, Chlordecone, Dieldrin, Endrin, Heptachlor, Heptabromo-biphenyl, Mirex, Toxaphene, HCH, DDT, PCB, PCDD/F, Benzo(a)pyrene, Benzo(b)fluoranthene, Benzo(k)fluoranthene, Indeno(1,2,3-cd)pyrene, Total 4 PAHs, HCB, PCP, SCCP	

Phosphate fertilisers (040414)

Phosphate fertilisers are produced by adding acid to ground or pulverised phosphate rock.

Table 3.34 Tier 2 emission factors for source category 2.B.5.a Other chemical industry, phosphate fertilisers (040414)

Tier 2 emission factors					
	Code	Name			
NFR Source Category	2.B.5.a	Other chemical industry (Please specify the sources included/excluded in the notes)			
Fuel	NA				
SNAP (if applicable)	040414	Phosphate fertilisers			
Technologies/Practices					
Region or regional conditions					
Abatement technologies					
Not applicable					
Not estimated	NOx, CO, NMVOC, SOx, NH3, Pb, Cd, Hg, As, Cr, Cu, Ni, Se, Zn, Aldrin, Chlordane, Chlordecone, Dieldrin, Endrin, Heptachlor, Heptabromo-biphenyl, Mirex, Toxaphene, HCH, DDT, PCB, PCDD/F, Benzo(a)pyrene, Benzo(b)fluoranthene, Benzo(k)fluoranthene, Indeno(1,2,3-cd)pyrene, Total 4 PAHs, HCB, PCP, SCCP				
Pollutant	Value	Unit	95% confidence interval		Reference
			Lower	Upper	
TSP	0.3	kg/ton produced	0.15	0.6	Visschedijk et al. (2004)
PM10	0.24	kg/ton produced	0.12	0.48	Visschedijk et al. (2004)
PM2.5	0.18	kg/ton produced	0.09	0.36	Visschedijk et al. (2004)

Ethylene (040501) and propylene (040502)

Ethylene is produced mainly by thermal cracking of naphtha fractions.⁽⁸⁾ Feedstock is preheated to 750–850 °C by adding hot products and steam to the reaction furnace. Additional steam is added to dilute the reaction mixture. After the reaction the gas mixture is quenched with cold oil, which in turn is used to produce steam. The oil gas steam mixture is separated in different fractions in a rectification section. In several steps the most important products of the mixture are separated. The low boiling products ethylene, propylene and the butylenes are separated after drying, compression and distillation.

For many applications ethylene must not contain acetylene. The acetylene is removed from the ethylene by selective hydrogenation.

⁽⁸⁾ Suitable feedstocks for olefins production range from light gases (e.g. ethane and LPGs) to the refinery liquid products (naphtha, gas-oil). Heavier feedstocks generally give a higher proportion of coproducts (propylene, butadiene, benzene) and need larger / more complex plants. (EC, 2003b)

After separation from the reaction mixture, ethane and propane are recycled to the reaction furnace feed, methane is used as fuel gas and hydrogen is used for hydrogenation (of acetylene). The C-4 mixture is used as feed for the butadiene production.

Different feedstock produces different ethylene yields and ranges of products. Generally, as the molecular weight of a feedstock increases, the yield of ethylene decreases and other products (e.g. propylene, butadiene and benzene) are produced in recoverable quantities. The typical feed (ethane to heavy petroleum distillates) results in a production of about 36 % ethylene, 13 % propylene, 8 % butylenes and 7 % aromatics. The IPPC reference document on Large Volume Organic Chemicals product yields for different feedstock (EC, 2003b).

The steam cracking olefins process is highly endothermic and requires large quantities of energy at high temperature (>800 °C) to achieve feedstock dissociation, whilst at the same time requiring the application of cryogenic separation processes (involving deep refrigeration to temperatures as low as –150 °C) to separate and purify the products.

The major emissions to air are CO₂, NO_x, CO produced during the combustion of fuel gases in the reaction furnace and hydrocarbons. The first three compounds are produced during the combustion of fuel gases in the reaction furnace and should be reported in 1.A.2.c, the hydrocarbons are mostly emitted due to leakage and flaring of the residual gases. The losses due to leakage can be limited by use of better seals and application of double seals near pumps.

The default emission factor for ethylene production emissions (provided in Table 3.35 below) only takes into account the amount of emitted NMVOC directly related to the ethylene production. In fact, actual emissions can relate not only to ethylene production but also to the production of other olefins as propylene.

Propylene is produced by thermal cracking of naphtha fractions, in the same process as the production of ethylene.

Table 3.35 Tier 2 emission factors for source category 2.B.5.a Other chemical industry, ethylene and propylene production

Tier 2 emission factors					
	Code	Name			
NFR Source Category	2.B.5.a	Other chemical industry (Please specify the sources included/excluded in the notes)			
Fuel	NA				
SNAP (if applicable)	040501	Ethylene			
Technologies/Practices					
Region or regional conditions					
Abatement technologies					
Not applicable					
Not estimated		NO _x , CO, SO _x , NH ₃ , TSP, PM ₁₀ , PM _{2.5} , Pb, Cd, Hg, As, Cr, Cu, Ni, Se, Zn, Aldrin, Chlordane, Chlordecone, Dieldrin, Endrin, Heptachlor, Heptabromo-biphenyl, Mirex, Toxaphene, HCH, DDT, PCB, PCDD/F, Benzo(a)pyrene, Benzo(b)fluoranthene, Benzo(k)fluoranthene, Indeno(1,2,3-cd)pyrene, Total 4 PAHs, HCB, PCP, SCCP			
Pollutant	Value	Unit	95% confidence interval		Reference
			Lower	Upper	
NMVOC	0.6	ton/kton produced	0.03	6	IPPC BREF LVOC (2003)

1,2 dichloroethane (except 04.05.05) (040503)

Most of the 1,2 dichloroethane (DCE, also referred to as ethylene dichloride, EDC) production is integrated with vinylchloride (VCM) production in the balanced process because of requirements of chlorine production sites and issues with chlorine transportation (EDC/VCM/PVC chain is the largest single chlorine consumer).

Therefore no Tier 2 emission factors are given for this process.

Vinylchloride (except 04.05.05) (040504)

Until the 1960s, VCM was essentially produced by the gas-phase hydrochlorination of acetylene with hydrochloric acid (HCl) over a mercuric-chloride-based catalyst. Due to the high cost of acetylene, however, and the emergence of large steam-crackers providing abundant ethylene, the ethylene route has replaced acetylene. The process is not used in the EU and is only possibly economic where inexpensive coal can be used to produce carbide-based acetylene (EC, 2003b).

Therefore, no Tier 2 emission factors are given for this process.

1,2 dichloroethane (DCE) + vinylchloride (VCM) (balanced process) (040505)

1,2-dichloroethane, also as ethylene dichloride (EDC), is mainly used to produce vinyl chloride monomer (VCM, chloroethene), the major precursor for PVC production. 1,2-Dichloroethane is also used generally as an intermediate for other organic chemical compounds, and as a solvent.

The main process used for vinylchloride production is the balanced process. When all the HCl generated in 1,2-Dichloroethane cracking is re-used in an oxychlorination section, and when no 1,2-dichloroethane or HCl is imported or exported, then the VCM unit is called a 'balanced unit'.

The balanced process consists of two routes operated simultaneously; in the direct chlorination route, chlorine is added to ethylene to form 1,2-dichloroethane; in the oxychlorination route, ethylene reacts with hydrogen chloride under oxidative conditions (presence of oxygen) also to form 1,2-dichloroethane.

The level of energy use is very dependent on the degree of local energy integration but typical figures are 0.2 t of steam, 1 MWh of natural gas and 0.2 MWh of electricity per tonne of VCM. Oxygen-based processes will also use significant additional electricity for the separation of oxygen from air (EC, 2003b).

The default Tier 2 emission factors as given in Table 3.37 below have been derived from all available data and information, taking into account the results of an assessment of emissions factors included in the earlier version of the Guidebook. Information on energy uses and emissions can also be found in the EC (2003b), where 1,2 dichloroethane + vinylchloride production is described as an illustrative process.

The major emissions to air are: 1,2-dichloroethane, vinylchloride, and other chlorinated hydrocarbons. The sources are mainly fugitive sources. Losses due to fugitive sources leakage can be limited by use of for instance more sophisticated types of seals.

Table 3.36 Tier 2 emission factors for source category 2.B.5.a Other chemical industry, 1,2 dichloroethane + vinylchloride (balanced process, DCE unit)

Tier 2 emission factors					
NFR Source Category	Code	Name			
Fuel	2.B.5.a	Other chemical industry (Please specify the sources included/excluded in the notes)			
SNAP (if applicable)	NA				
Technologies/Practices	040505	1,2 dichloroethane + vinylchloride (balanced process)			
Region or regional conditions		balanced process, DCE unit			
Abatement technologies		unabated			
Not applicable					
Not estimated		NOx, CO, SOx, NH3, TSP, PM10, PM2.5, Pb, Cd, Hg, As, Cr, Cu, Ni, Se, Zn, Aldrin, Chlordane, Chlordecone, Dieldrin, Endrin, Heptachlor, Heptabromo-biphenyl, Mirex, Toxaphene, HCH, DDT, PCB, PCDD/F, Benzo(a)pyrene, Benzo(b)fluoranthene, Benzo(k)fluoranthene, Indeno(1,2,3-cd)pyrene, Total 4 PAHs, HCB, PCP, SCCP			
Pollutant	Value	Unit	95% confidence interval		Reference
			Lower	Upper	
NMVOc	2500	g/ton produced	2.5	5870	IPPC BREF LVOC (2003)

Table 3.37 Tier 2 emission factors for source category 2.B.5.a Other chemical industry, 1,2 dichloroethane + vinylchloride (balanced process, VCM unit)

Tier 2 emission factors					
NFR Source Category	Code	Name			
Fuel	2.B.5.a	Other chemical industry (Please specify the sources included/excluded in the notes)			
SNAP (if applicable)	NA				
Technologies/Practices	040505	1,2 dichloroethane + vinylchloride (balanced process)			
Region or regional conditions		Balanced process, vinylchloride production			
Abatement technologies		unabated			
Not applicable					
Not estimated		NOx, CO, SOx, NH3, TSP, PM10, PM2.5, Pb, Cd, Hg, As, Cr, Cu, Ni, Se, Zn, Aldrin, Chlordane, Chlordecone, Dieldrin, Endrin, Heptachlor, Heptabromo-biphenyl, Mirex, Toxaphene, HCH, DDT, PCB, PCDD/F, Benzo(a)pyrene, Benzo(b)fluoranthene, Benzo(k)fluoranthene, Indeno(1,2,3-cd)pyrene, Total 4 PAHs, HCB, PCP, SCCP			
Pollutant	Value	Unit	95% confidence interval		Reference
			Lower	Upper	
NMVOc	2500	g/ton produced	20	5000	IPPC BREF LVOC (2003)

Polyethylene low density (040506) and polyethylene high density (040507)

The present sub-section includes the manufacture of polyethylene. Polyethylene is produced in low density polyethylene (LDPE), linear low density polyethylene (LLDPE) and high density polyethylene (HDPE).

This sub-section includes all emissions during the processing of chemical feed stocks to produce polyethylene, including process and fugitive emissions. Emissions from storage of feed stocks, intermediates and products are not included.

Polyethylene is a polymer of ethylene and has the general empirical formula $(-CH_2CH_2-)_n$. The manufacturing process used depends upon the type of polymer produced.

LDPE is a tough waxy polymer, with approximately 2 % branching between polymer chains and a density of about 0.92 t/m^3 . LDPE is generally produced by high pressure and high temperature catalytic polymerisation of ethylene in a tubular or autoclave reactor.

LLDPE is a crystalline polymer with no chain branching and a density comparable to that of LDPE. A low pressure method is generally used in which ethylene and a co-monomer such as butene or hexene is catalytically polymerised.

HDPE is a crystalline polymer with no chain branching and a density of about 0.96 t/m^3 . HDPE is produced by low pressure polymerisation of ethylene in a reactor containing a liquid hydrocarbon

diluent and in the presence of Ziegler catalysts. The polymer produces slurry as it forms and is filtered from the solvent.

The major emissions to air are NMVOC unreacted monomer (i.e. ethylene), some partially reacted monomer (alkenes and alkanes) together with small amounts of additives. NMVOCs are emitted primarily through leakages and may be production time dependent rather than production dependent.

Control techniques are primarily through replacement of leaking valves etc. and regular maintenance.

The Tier 2 emission factors presented in Tables 3.38 and 3.39 are in kg NMVOC/t polyethylene produced.

Table 3.38 Tier 2 emission factors for source category 2.B.5.a Other chemical industry, polyethylene low density (040506)

Tier 2 emission factors					
	Code	Name			
NFR Source Category	2.B.5.a	Other chemical industry (Please specify the sources included/excluded in the notes)			
Fuel	NA				
SNAP (if applicable)	040506	Polyethylene Low Density			
Technologies/Practices					
Region or regional conditions					
Abatement technologies					
Not applicable					
Not estimated		NOx, CO, SOx, NH3, PM10, PM2.5, Pb, Cd, Hg, As, Cr, Cu, Ni, Se, Zn, Aldrin, Chlordane, Chlordecone, Dieldrin, Endrin, Heptachlor, Heptabromo-biphenyl, Mirex, Toxaphene, HCH, DDT, PCB, PCDD/F, Benzo(a)pyrene, Benzo(b)fluoranthene, Benzo(k)fluoranthene, Indeno(1,2,3-cd)pyrene, Total 4 PAHs, HCB, PCP, SCCP			
Pollutant	Value	Unit	95% confidence interval		Reference
			Lower	Upper	
NMVOC	2.4	kg/ton produced	1	4.5	IPPC BREF Polymers
TSP	31	g/ton produced	17	61	IPPC BREF Polymers

Table 3.39 Tier 2 emission factors for source category 2.B.5.a Other chemical industry, polyethylene high density (040507)

Tier 2 emission factors					
	Code	Name			
NFR Source Category	2.B.5.a	Other chemical industry (Please specify the sources included/excluded in the notes)			
Fuel	NA				
SNAP (if applicable)	040507	Polyethylene High Density			
Technologies/Practices					
Region or regional conditions					
Abatement technologies					
Not applicable					
Not estimated		NOx, CO, SOx, NH3, PM10, PM2.5, Pb, Cd, Hg, As, Cr, Cu, Ni, Se, Zn, Aldrin, Chlordane, Chlordecone, Dieldrin, Endrin, Heptachlor, Heptabromo-biphenyl, Mirex, Toxaphene, HCH, DDT, PCB, PCDD/F, Benzo(a)pyrene, Benzo(b)fluoranthene, Benzo(k)fluoranthene, Indeno(1,2,3-cd)pyrene, Total 4 PAHs, HCB, PCP, SCCP			
Pollutant	Value	Unit	95% confidence interval		Reference
			Lower	Upper	
NMVOC	2.3	kg/ton produced	1.9	5.8	IPPC BREF Polymers
TSP	97	g/ton produced	56	175	IPPC BREF Polymers

Polyvinylchloride (040508)

Polyvinylchloride is made by polymerising vinylchloride. Several processes are available: mass polymerisation (which accounts for 8 % of PVC production), emulsion polymerisation (E-PVC) (12 %) or suspension polymerisation (S-PVC) (80 %).

The different processes are:

- **Mass polymerisation (a batch process).** This is a two stage process. In the first stage, the liquid vinylchloride monomer with an initiator is prepolymerised for 1–1.5 hours until 7–10 % monomer conversion is reached. The grains resulting from this stage function as skeleton seeds for growing in the second stage. In the second stage, a mixture of the effluent from the first reactor, extra monomer and initiator are fed to an autoclave. The reaction is stopped as the pressure drops and no free liquid monomer is available; the free liquid monomer is needed for heat removal by a condenser. The unreacted monomer, adsorbed in the polymer grains, is removed by vacuum and recovered by vapour compression and condensation in a recycle condenser. The reaction temperature is 50–70 °C.
- **Suspension polymerisation (a batch process).** Vinylchloride monomer is dispersed in water by agitation. Polymerisation starts by adding monomer-soluble initiators and addition of suspension stabilisers and suspending agents minimises coalescence of the grains. The reaction temperature is used for the control of the polymer molecular weight and varies between 45 and 75 °C. Reactor pressure is between 800 and 1200 kPa. Reaction is carried out until 85 % conversion is reached. After polymerisation most unreacted monomer is recovered in a dump tank. The remaining monomer is stripped from the polymer with steam. The waste water is separated in a centrifugator. The PVC resin is dried with hot air and stored.
- **Emulsion polymerisation (batch, semi-continuous or continuous).** Vinylchloride monomer is emulsified in water by means of surface-active agents. The monomer is thus present as droplets and a small fraction is dissolved in micelles. Water-soluble initiator is added and polymerisation starts in the micelles. Monomer is added to the latex particles (micelles) by diffusion from the emulsion droplets through the aqueous phase.

Energy is mainly used in the form of steam and electrical power. Typical energy consumption of PVC processes is (EC, 2006d):

- S-PVC
 - thermal energy: 2–3 GJ/t of PVC;
 - electrical energy 0.7–1.1 GJ/t of PVC;
- E-PVC
 - thermal energy 6–9 GJ/t of PVC;
 - electrical energy 1.4–2.2 GJ/t of PVC.

The major emissions to air are vinylchloride due to leakage and storage loss. The losses due to leakage can be limited by use of certain types of seals and application of double seals near pumps. The Tier 2 emission factors presented in Tables 3.40 and 3.41 are in kg NMVOC/t PVC produced.

Table 3.40 Tier 2 emission factors for source category 2.B.5.a Other chemical industry, polyvinylchloride, suspension PVC (S-PVC)

Tier 2 emission factors					
	Code	Name			
NFR Source Category	2.B.5.a	Other chemical industry (Please specify the sources included/excluded in the notes)			
Fuel	NA				
SNAP (if applicable)	040508	Polyvinylchloride			
Technologies/Practices	Suspension PVC process (S-PVC)				
Region or regional conditions					
Abatement technologies					
Not applicable					
Not estimated	NOx, CO, SOx, NH3, Pb, Cd, Hg, As, Cr, Cu, Ni, Se, Zn, Aldrin, Chlordane, Chlordecone, Dieldrin, Endrin, Heptachlor, Heptabromo-biphenyl, Mirex, Toxaphene, HCH, DDT, PCB, PCDD/F, Benzo(a)pyrene, Benzo(b)fluoranthene, Benzo(k)fluoranthene, Indeno(1,2,3-cd)pyrene, Total 4 PAHs, HCB, PCP, SCCP				
Pollutant	Value	Unit	95% confidence interval		Reference
			Lower	Upper	
NMVOc	96	g/ton produced	40	3000	EGTEI (2005)
TSP	263	g/ton produced	53	1300	Visschedijk et al. (2004)
PM10	100	g/ton produced	20	500	Visschedijk et al. (2004)
PM2.5	5	g/ton produced	2	50	Visschedijk et al. (2004)

Table 3.41 Tier 2 emission factors for source category 2.B.5.a Other chemical industry, polyvinylchloride, emulsion PVC (E-PVC)

Tier 2 emission factors					
	Code	Name			
NFR Source Category	2.B.5.a	Other chemical industry (Please specify the sources included/excluded in the notes)			
Fuel	NA				
SNAP (if applicable)	040508	Polyvinylchloride			
Technologies/Practices	Emulsion PVC process (E-PVC)				
Region or regional conditions					
Abatement technologies					
Not applicable					
Not estimated	NOx, CO, SOx, NH3, Pb, Cd, Hg, As, Cr, Cu, Ni, Se, Zn, Aldrin, Chlordane, Chlordecone, Dieldrin, Endrin, Heptachlor, Heptabromo-biphenyl, Mirex, Toxaphene, HCH, DDT, PCB, PCDD/F, Benzo(a)pyrene, Benzo(b)fluoranthene, Benzo(k)fluoranthene, Indeno(1,2,3-cd)pyrene, Total 4 PAHs, HCB, PCP, SCCP				
Pollutant	Value	Unit	95% confidence interval		Reference
			Lower	Upper	
NMVOc	813	g/ton produced	18	1000	IPPC BREF Polymers (2003)
TSP	263	g/ton produced	53	1300	Visschedijk et al. (2004)
PM10	100	g/ton produced	20	500	Visschedijk et al. (2004)
PM2.5	5	g/ton produced	2	50	Visschedijk et al. (2004)

Polypropylene (040509)

Polypropylene (PP) is one of the economically most important thermoplastic materials. Polypropylene is produced by polymerisation of propylene. Most of the processes applied for the production of polypropylene are very similar to the ones used to produce high density polyethylene (EC, 2006d). The most important and most widely used processes for the production of polypropylene are:

- **gas phase processes;**
- **suspension processes.**

The traditional suspension processes using an organic diluent are known within the PP nomenclature as 'slurry' processes. Modern suspension processes use a liquid monomer instead of a solvent, known as 'bulk' processes. The major emission to air is propylene. The losses due to fugitives can be limited by use of modern abatement methods. Emission and consumption levels for

the production of PP can be considered to be equivalent to comparable PE processes. Comparable PP processes are:

- traditional PP suspension (slurry) process with the HDPE slurry process;
- PP gas phase process with the production of LLDPE;
- PP suspension (bulk) process with a modern PE gas phase process.

The Tier 2 emission factors presented in Table 3.42 are in kg NMVOC/t PP produced.

Table 3.42 Tier 2 emission factors for source category 2.B.5.a Other chemical industry, polypropylene (040509)

Tier 2 emission factors					
	Code	Name			
NFR Source Category	2.B.5.a	Other chemical industry (Please specify the sources included/excluded in the notes)			
Fuel	NA				
SNAP (if applicable)	040509	Polypropylene			
Technologies/Practices					
Region or regional conditions					
Abatement technologies					
Not applicable					
Not estimated		NOx, CO, SOx, NH3, PM10, PM2.5, Pb, Cd, Hg, As, Cr, Cu, Ni, Se, Zn, Aldrin, Chlordane, Chlordecone, Dieldrin, Endrin, Heptachlor, Heptabromo-biphenyl, Mirex, Toxaphene, HCH, DDT, PCB, PCDD/F, Benzo(a)pyrene, Benzo(b)fluoranthene, Benzo(k)fluoranthene, Indeno(1,2,3-cd)pyrene, Total 4 PAHs, HCB, PCP, SCCP			
Pollutant	Value	Unit	95% confidence interval		Reference
			Lower	Upper	
NMVOC	4	kg/ton produced	0.5	20	Guidebook (2006)
TSP	1.5	kg/ton produced	0.5	5	US EPA AP42

Styrene (040510)

Styrene can be made from ethylbenzene in two ways, either by the dehydrogenation process or the oxidation process. The hydrogenation process route is used in the majority of plants and can be operated in two ways; in both processes steam is used for heat addition to the feed and for retarding coke deposition.

- **The adiabatic process** is the most common. Preheated ethylbenzene is mixed with superheated (800–950°C) steam (ratio 1:<14) and led over the catalyst. Operation conditions are temperatures of 610–660 °C and pressure of <138 kPa.
- **The isothermal process** uses a tubular reactor with catalyst. Reaction heat is provided by indirect heat exchange. Operation conditions are temperatures of 580–610 °C and pressure of <138 kPa. The ethylene/steam ratio is 1:6–8.

The catalyst used in both processes is Fe₂O₃ with Cr₂O₃ as stabiliser and K₂CO₃ as coke formation retardant. After the reactor a settler separates vapour (vent gas; mostly hydrogen), water (saturated with aromatics) and liquid hydrocarbons (crude styrene). In the purification section, which operates under vacuum, inhibitors are used to suppress polymerisation of styrene. Benzene is recovered and recycled to the ethylbenzene plant; the residue is used as fuel. Ethylbenzene is recovered and recycled to the reactor feed.

The major emissions to air are methane (emitted due to combustion and not to be estimated using methods presented in chapter 1.A.2) and styrene and toluene due to leakage and storage loss. The losses due to leakage can be limited by using certain types of seals and the application of double

seals near pumps. The Tier 2 emission factors presented in Table 3.43 are in kg NMVOC/t styrene produced.

Table 3.43 Tier 2 emission factors for source category 2.B.5.a Other chemical industry, styrene (040510)

Tier 2 emission factors					
	Code	Name			
NFR Source Category	2.B.5.a	Other chemical industry (Please specify the sources included/excluded in the notes)			
Fuel	NA				
SNAP (if applicable)	040510	Styrene			
Technologies/Practices					
Region or regional conditions					
Abatement technologies					
Not applicable					
Not estimated		NOx, CO, SOx, NH ₃ , TSP, PM ₁₀ , PM _{2.5} , Pb, Cd, Hg, As, Cr, Cu, Ni, Se, Zn, Aldrin, Chlordane, Chlordecone, Dieldrin, Endrin, Heptachlor, Heptabromo-biphenyl, Mirex, Toxaphene, HCH, DDT, PCB, PCDD/F, Benzo(a)pyrene, Benzo(b)fluoranthene, Benzo(k)fluoranthene, Indeno(1,2,3-cd)pyrene, Total 4 PAHs, HCB, PCP, SCCP			
Pollutant	Value	Unit	95% confidence interval		Reference
			Lower	Upper	
NMVOC	1	kg/ton produced	0.05	20	Guidebook (2006)

Polystyrene(040511)

Polystyrene is made by polymerising styrene monomer. Most polystyrene is produced by free-radical polymerisation. The process of producing polystyrene requires one reactor or a series of reactors controlled by a set of parameters such as temperature, pressure and conversion rate. The process requires the addition of several raw materials, i.e. solvent, initiator (optional), and chain transfer agents, into the reactors under well defined conditions. The reaction heat is removed by transfer to the new incoming feed and/or by the evaporation of solvent and/or by heat transfer medium, i.e. circulating oil. The crude product coming out of the reactor train has a solid content of between 60 and 90 %. To remove the unconverted monomer and solvent from the crude product, it is heated to about 220–260 °C and led through a high vacuum. This is called the devolatilisation step and can have one or two stages. Finally, the cleaned, high purity polymer is granulated. The monomer and solvent are stripped in the devolatilisation section and recycled within the process (EC, 2006d).

Three main types of polystyrene can be distinguished. First, transparent and brittle general purpose polystyrene (GPPS). Second, white, non-shiny flexible, rubber modified polystyrene, which is called (high) impact polystyrene (IPS or HIPS). Third, expandable or foam polystyrene (EPS), which uses different production techniques because it is impregnated with a blowing agent like pentane.

The major emissions to air are styrene and other hydrocarbons. The losses due to leakage can be limited by using certain types of seals and application of double seals near pumps. The Tier 2 emission factors presented in Table 3.44, 3.45 and 3.46 are in kg NMVOC/t polystyrene produced.

Table 3.44 Tier 2 emission factors for source category 2.B.5.a Other chemical industry, polystyrene, general purpose polystyrene (GPPS) (040511)

Tier 2 emission factors					
	Code	Name			
NFR Source Category	2.B.5.a	Other chemical industry (Please specify the sources included/excluded in the notes)			
Fuel	NA				
SNAP (if applicable)	040511	Polystyrene			
Technologies/Practices	Production of General purpose polystyrene (GPPS)				
Region or regional conditions					
Abatement technologies					
Not applicable					
Not estimated	NOx, CO, SOx, NH3, PM10, PM2.5, Pb, Cd, Hg, As, Cr, Cu, Ni, Se, Zn, Aldrin, Chlordane, Chlordecone, Dieldrin, Endrin, Heptachlor, Heptabromo-biphenyl, Mirex, Toxaphene, HCH, DDT, PCB, PCDD/F, Benzo(a)pyrene, Benzo(b)fluoranthene, Benzo(k)fluoranthene, Indeno(1,2,3-cd)pyrene, Total 4 PAHs, HCB, PCP, SCCP				
Pollutant	Value	Unit	95% confidence interval		Reference
			Lower	Upper	
NMVOG	120	g/ton produced	50	300	IPPC BREF Polymers
TSP	4	g/ton produced	1	7	Guidebook (2006)

Table 3.45 Tier 2 emission factors for source category 2.B.5.a Other chemical industry, polystyrene, high impact polystyrene (HIPS) (040511)

Tier 2 emission factors					
	Code	Name			
NFR Source Category	2.B.5.a	Other chemical industry (Please specify the sources included/excluded in the notes)			
Fuel	NA				
SNAP (if applicable)	040511	Polystyrene			
Technologies/Practices	High impact polystyrene (HIPS)				
Region or regional conditions	representative for variety of manufacturing HIPS in Europe.				
Abatement technologies					
Not applicable					
Not estimated	NOx, CO, SOx, NH3, PM10, PM2.5, Pb, Cd, Hg, As, Cr, Cu, Ni, Se, Zn, Aldrin, Chlordane, Chlordecone, Dieldrin, Endrin, Heptachlor, Heptabromo-biphenyl, Mirex, Toxaphene, HCH, DDT, PCB, PCDD/F, Benzo(a)pyrene, Benzo(b)fluoranthene, Benzo(k)fluoranthene, Indeno(1,2,3-cd)pyrene, Total 4 PAHs, HCB, PCP, SCCP				
Pollutant	Value	Unit	95% confidence interval		Reference
			Lower	Upper	
NMVOG	120	g/ton produced	50	1000	IPPC BREF Polymers
TSP	4	g/ton produced	1	7	Guidebook (2006)

Table 3.46 Tier 2 emission factors for source category 2.B.5.a Other chemical industry, polystyrene, expandable polystyrene (040511)

Tier 2 emission factors					
	Code	Name			
NFR Source Category	2.B.5.a	Other chemical industry (Please specify the sources included/excluded in the notes)			
Fuel	NA				
SNAP (if applicable)	040511	Polystyrene			
Technologies/Practices	Expandable polystyrene (EPS)				
Region or regional conditions	representative for variety of manufacturing EPS in Europe.				
Abatement technologies					
Not applicable					
Not estimated	NOx, CO, SOx, NH3, PM10, PM2.5, Pb, Cd, Hg, As, Cr, Cu, Ni, Se, Zn, Aldrin, Chlordane, Chlordecone, Dieldrin, Endrin, Heptachlor, Heptabromo-biphenyl, Mirex, Toxaphene, HCH, DDT, PCB, PCDD/F, Benzo(a)pyrene, Benzo(b)fluoranthene, Benzo(k)fluoranthene, Indeno(1,2,3-cd)pyrene, Total 4 PAHs, HCB, PCP, SCCP				
Pollutant	Value	Unit	95% confidence interval		Reference
			Lower	Upper	
NMVOG	3.2	kg/ton produced	1.6	11.5	IPPC BREF Polymers
TSP	30	g/ton produced	20	125	IPPC BREF Polymers

Styrene butadiene (040512), styrene-butadiene latex (040513) and styrene-butadiene rubber (SBR) (040514)

The reaction used to produce styrene-butadiene copolymers is emulsion polymerisation. The copolymerisation of styrene and butadiene can be done in several ways. The present Guidebook distinguishes the production of two styrene-butadiene copolymers: styrene butadiene latex (a colloidal aqueous emulsion of an elastomer) and styrene butadiene rubber.

- **SB latex** is made by:
 - Emulsion polymerisation. The reaction is started with free-radical initiators. The emulsion consists for 5–10 wt.% non-rubber, more than half being emulsifiers (others components being initiators, modifiers, inorganic salts, free alkali and short stops). A polymer string consists of random blocks of styrene and butadiene.
 - Another way of producing SB latex is emulsification of SB rubber. SB rubber particles are dissolved in water with dispersing and wetting agents.
- **SB rubber** can produced by:
 - Anionic polymerisation. The reaction can be started with reaction of the initiator with either styrene or butadiene. When the reaction starts with styrene, the propagation can be with styrene or butadiene.
 - Polymerisation with the redox-system: oxidising compounds (peroxides), reducing compounds and heavy metalions, like Fe²⁺.

The losses due to leakage can be limited by using better abatement methods.

Table 3.47 Tier 2 emission factors for source category 2.B.5.a Other chemical industry, styrene butadiene (040512), styrene-butadiene latex (040513) and styrene-butadiene rubber (SBR) (040514)

Tier 2 emission factors					
NFR Source Category	Code	Name			
	2.B.5.a	Other chemical industry (Please specify the sources included/excluded in the notes column to the right)			
Fuel	NA				
SNAP (if applicable)	040512	Styrene butadiene			
Technologies/Practices	SB polymer in general				
Region or regional conditions					
Abatement technologies	Not applicable				
Not estimated	NO _x , CO, SO _x , NH ₃ , TSP, PM ₁₀ , PM _{2.5} , Pb, Cd, Hg, As, Cr, Cu, Ni, Se, Zn, Aldrin, Chlordane, Chlordecone, Dieldrin, Endrin, Heptachlor, Heptabromo-biphenyl, Mirex, Toxaphene, HCH, DDT.				
Pollutant	Value	Unit	95% confidence interval		Reference
			Lower	Upper	
NMVOC	0.27	kg/ton produced	0.17	0.54	IPPC BREF Polymers

Table 3.48 Tier 2 emission factors for source category 2.B.5.a Other chemical industry, styrene-butadiene latex (040513)

Tier 2 emission factors					
NFR Source Category	Code	Name			
Fuel	2.B.5.a	Other chemical industry (Please specify the sources included/excluded in the notes)			
SNAP (if applicable)	NA				
Technologies/Practices	040513	Styrene-butadiene latex			
Region or regional conditions	Emulsion polymerisation				
Abatement technologies	Not applicable				
Not estimated	NO _x , CO, SO _x , NH ₃ , TSP, PM ₁₀ , PM _{2.5} , Pb, Cd, Hg, As, Cr, Cu, Ni, Se, Zn, Aldrin, Chlordane, Chlordecone, Dieldrin, Endrin, Heptachlor, Heptabromo-biphenyl, Mirex, Toxaphene, HCH, DDT, PCB, PCDD/F, Benzo(a)pyrene, Benzo(b)fluoranthene, Benzo(k)fluoranthene, Indeno(1,2,3-cd)pyrene, Total 4 PAHs, HCB, PCP, SCCP				
Pollutant	Value	Unit	95% confidence interval		Reference
			Lower	Upper	
NMVOC	9	kg/ton produced	8	10	US EPA AP42

Table 3.49 Tier 2 emission factors for source category 2.B.5.a Other chemical industry, styrene-butadiene rubber (SBR) (040514)

Tier 2 emission factors					
NFR Source Category	Code	Name			
Fuel	2.B.5.a	Other chemical industry (Please specify the sources included/excluded in the notes)			
SNAP (if applicable)	NA				
Technologies/Practices	040514	Styrene-butadiene rubber (SBR)			
Region or regional conditions					
Abatement technologies	Not applicable				
Not estimated	NO _x , CO, SO _x , NH ₃ , TSP, PM ₁₀ , PM _{2.5} , Pb, Cd, Hg, As, Cr, Cu, Ni, Se, Zn, Aldrin, Chlordane, Chlordecone, Dieldrin, Endrin, Heptachlor, Heptabromo-biphenyl, Mirex, Toxaphene, HCH, DDT, PCB, PCDD/F, Benzo(a)pyrene, Benzo(b)fluoranthene, Benzo(k)fluoranthene, Indeno(1,2,3-cd)pyrene, Total 4 PAHs, HCB, PCP, SCCP				
Pollutant	Value	Unit	95% confidence interval		Reference
			Lower	Upper	
NMVOC	5	kg/Mg produced	2	6	IPPC BREF Polymers

Acrylonitrile butadiene styrene (ABS) resins (040515)

Acrylonitrile butadiene styrene (ABS) is a combination of a graft ⁽⁹⁾ copolymer and a polymer mixture. ABS can be produced in three ways:

- **Emulsion polymerisation.** This is a two step process. In the first step rubber latex is made, usually in a batch process. In the second step, which can be operated as batch, semi-batch and continuous, styrene and acrylonitrile are polymerised in the rubber latex solution to form ABS latex. The ABS polymer is recovered through coagulation of the ABS latex by adding a destabilising agent. The resulting slurry is filtered or centrifuged to recover the ABS resin. The ABS resin is then dried.
- **Mass (or bulk) polymerisation.** Two or more continuous flow reactors are used in this process. Rubber is dissolved in the monomers, being styrene and acrylonitrile. During the reaction the dissolved rubber is replaced by the styrene acrylonitrile copolymer (SAN) and forms discrete rubber particles. Part of the SAN is grafted on the rubber particles, while another part is occluded in the particles. The reaction mixture contains several additives, e.g. initiator, chain-transfer agents, these are needed in the polymerisation. The product is

⁽⁹⁾ Graft polymer: a polymer with a 'backbone' of one type of monomer and with 'ribs' of copolymers of two other monomers.

devolatilised to remove unreacted monomer, which are recycled to the reactor, and then pelletised.

- **Mass-suspension.** This batch process starts with a mass polymerisation (see above) which is stopped at a monomer conversion of 15–30 %. Then a suspension reaction completes the polymerisation. For this reaction the mixture of polymer and monomer is suspended in water using a suspending agent and then the polymerisation is continued. Unreacted monomers are stripped, then the product is centrifuged and dried.

The losses due to leakage can be limited by use of certain types of seals and the application of double seals near pumps.

Table 3.50 Tier 2 emission factors for source category 2.B.5.a Other chemical industry, ABS production (040515)

Tier 2 emission factors					
	Code	Name			
NFR Source Category	2.B.5.a	Other chemical industry (Please specify the sources included/excluded in the notes)			
Fuel	NA				
SNAP (if applicable)	040515	Acrylonitrile Butadiene Styrene (ABS) resins			
Technologies/Practices					
Region or regional conditions					
Abatement technologies					
Not applicable					
Not estimated		NOx, CO, SOx, NH3, TSP, PM10, PM2.5, Pb, Cd, Hg, As, Cr, Cu, Ni, Se, Zn, Aldrin, Chlordane, Chlordane, Dieldrin, Endrin, Heptachlor, Heptabromo-biphenyl, Mirex, Toxaphene, HCH, DDT, PCB, PCDD/F, Benzo(a)pyrene, Benzo(b)fluoranthene, Benzo(k)fluoranthene, Indeno(1,2,3-cd)pyrene, Total 4 PAHs, HCB, PCP, SCCP			
Pollutant	Value	Unit	95% confidence interval		Reference
			Lower	Upper	
NMVOC	3	kg/ton produced	1	25	Guidebook (2006)

Ethylene oxide (040516)

Ethylene oxide (EO) is produced when ethylene and oxygen react exothermically at elevated temperature (200–300 °C) and pressure (15–25 bar) on a silver catalyst. This direct oxidation process is the most commonly used. EO can also be produced using the more costly chlorohydrin route. This is a two stage process which uses the liquid phase reaction between ethylene and hypochlorous acid to form an ethylene chlorohydrin intermediate, followed by conversion to EO with hydrated lime. Although ethylene oxide and ethylene glycols (EG) can be produced separately, nearly all European installations produce a mix of the products on integrated plants.

An EO / EG process is both a consumer and a producer of energy. The EO section is typically a net energy producer and this is used to generate steam. The steam production depends on the EO catalyst selectivity, which in turn depends on the type and age of catalyst operating conditions. The EG section is a net consumer of energy. A multi-effect evaporator system can be used in the glycols de-watering section to reduce energy consumption. Furthermore, the heat released in the glycols reactor is used to reduce energy consumption at glycols de-watering. Catalyst selectivity and the relative sizes of the EO and EG sections influence the overall energy balance of the unit and define if a plant is a net steam importer or exporter.

In air-based plants, NMVOCs mainly arise from the secondary absorber vent and the fractionating tower vent, while in oxygen-based plants the main sources are the absorber vent and the carbon dioxide absorption system.

Unabated Tier 2 emission factors are presented in Tables 3.51. However, in many cases, the gaseous effluent stream is flared, oxidised (thermally or catalytically) or sent to a boiler or power plant, together with other streams.

Table 3.51 Tier 2 emission factors for source category 2.B.5.a Other chemical industry, ethylene oxide production

Tier 2 emission factors					
	Code	Name			
NFR Source Category	2.B.5.a	Other chemical industry (Please specify the sources included/excluded in the notes)			
Fuel	NA				
SNAP (if applicable)	040516	Ethylene oxide			
Technologies/Practices					
Region or regional conditions					
Abatement technologies	unabated				
Not applicable					
Not estimated	NOx, CO, SOx, NH3, TSP, PM10, PM2.5, Pb, Cd, Hg, As, Cr, Cu, Ni, Se, Zn, Aldrin, Chlordane, Chlordecone, Dieldrin, Endrin, Heptachlor, Heptabromo-biphenyl, Mirex, Toxaphene, HCH, DDT, PCB, PCDD/F, Benzo(a)pyrene, Benzo(b)fluoranthene, Benzo(k)fluoranthene, Indeno(1,2,3-cd)pyrene, Total 4 PAHs, HCB, PCP, SCCP				
Pollutant	Value	Unit	95% confidence interval		Reference
			Lower	Upper	
NM VOC	2	kg/ton produced	0.5	3	IPPC BREF LVOC (2003)

Formaldehyde (040517)

Formaldehyde is produced from methanol, either by catalytic oxidation under air deficiency ('silver process') or air excess ('oxide process'). European formaldehyde production capacity is split roughly equally between the silver and oxide routes. Tier 2 emission factors are presented below for both processes, derived from the IPPC BREF document on the Large Volume Organic Chemical industry (EC, 2003b), which describes the production of formaldehyde as an illustrative process.

Table 3.52 Tier 2 emission factors for source category 2.B.5.a Other chemical industry, formaldehyde production, silver process, unabated

Tier 2 emission factors					
	Code	Name			
NFR Source Category	2.B.5.a	Other chemical industry (Please specify the sources included/excluded in the notes)			
Fuel	NA				
SNAP (if applicable)	040517	Formaldehyde			
Technologies/Practices	Formaldehyde, silver proces				
Region or regional conditions					
Abatement technologies	unabated				
Not applicable					
Not estimated	NOx, SOx, NH3, TSP, PM10, PM2.5, Pb, Cd, Hg, As, Cr, Cu, Ni, Se, Zn, Aldrin, Chlordane, Chlordecone, Dieldrin, Endrin, Heptachlor, Heptabromo-biphenyl, Mirex, Toxaphene, HCH, DDT, PCB, PCDD/F, Benzo(a)pyrene, Benzo(b)fluoranthene, Benzo(k)fluoranthene, Indeno(1,2,3-cd)pyrene, Total 4 PAHs, HCB, PCP, SCCP				
Pollutant	Value	Unit	95% confidence interval		Reference
			Lower	Upper	
CO	12	kg/ton produced	10	14	IPPC BREF LVOC (2003)
NM VOC	7	kg/ton produced	6	10	IPPC BREF LVOC (2003)

Table 3.53 Tier 2 emission factors for source category 2.B.5.a Other chemical industry, formaldehyde production, oxide process, unabated

Tier 2 emission factors					
	Code	Name			
NFR Source Category	2.B.5.a	Other chemical industry (Please specify the sources included/excluded in the notes)			
Fuel	NA				
SNAP (if applicable)	040517	Formaldehyde			
Technologies/Practices	Formaldehyde, oxide proces				
Region or regional conditions					
Abatement technologies	unabated				
Not applicable					
Not estimated	NOx, SOx, NH3, TSP, PM10, PM2.5, Pb, Cd, Hg, As, Cr, Cu, Ni, Se, Zn, Aldrin, Chlordane, Chlordecone, Dieldrin, Endrin, Heptachlor, Heptabromo-biphenyl, Mirex, Toxaphene, HCH, DDT, PCB, PCDD/F, Benzo(a)pyrene, Benzo(b)fluoranthene, Benzo(k)fluoranthene, Indeno(1,2,3-cd)pyrene, Total 4 PAHs, HCB, PCP, SCCP				
Pollutant	Value	Unit	95% confidence interval		Reference
			Lower	Upper	
CO	0.2	kg/ton produced	0.1	0.3	IPPC BREF LVOC (2003)
NMVOC	1.5	kg/ton produced	0.5	5	IPPC BREF LVOC (2003)

Table 3.54 Tier 2 emission factors for source category 2.B.5.a Other chemical industry, formaldehyde production, silver process, abated

Tier 2 emission factors					
	Code	Name			
NFR Source Category	2.B.5.a	Other chemical industry (Please specify the sources included/excluded in the notes)			
Fuel	NA				
SNAP (if applicable)	040517	Formaldehyde			
Technologies/Practices	Formaldehyde, silver proces				
Region or regional conditions					
Abatement technologies	thermal or catalytic incineration				
Not applicable					
Not estimated	NOx, SOx, NH3, PM10, PM2.5, Pb, Cd, Hg, As, Cr, Cu, Ni, Se, Zn, Aldrin, Chlordane, Chlordecone, Dieldrin, Endrin, Heptachlor, Heptabromo-biphenyl, Mirex, Toxaphene, HCH, DDT, PCB, PCDD/F, Benzo(a)pyrene, Benzo(b)fluoranthene, Benzo(k)fluoranthene, Indeno(1,2,3-cd)pyrene, Total 4 PAHs, HCB, PCP, SCCP				
Pollutant	Value	Unit	95% confidence interval		Reference
			Lower	Upper	
CO	0.2	kg/ton produced	0.1	0.3	IPPC BREF LVOC (2003)
NMVOC	0.0016	kg/ton produced	0.0008	0.0032	IPPC BREF LVOC (2003)
TSP	0.0005	kg/ton produced	0.00025	0.001	IPPC BREF LVOC (2003)

Ethylbenzene (040518)

Ethylbenzene can be produced both in liquid and vapour phase. All processes use a catalyst with aluminium.

The liquid phase ethylbenzene production can be operated in two ways:

- The Union Carbide/Badger process.** Ethylene is sparged in the reactor containing a mixture of benzene, catalyst (AlCl₃) and a promotor (monochloroethane or sometimes HCl). The reaction mixture is agitated to disperse the catalyst-complex and operated at low temperature and pressure. Almost complete conversion of ethylene is obtained. In the reactor polyethylbenzenes are transalkylated to ethylbenzene. The reactor effluent is cooled and led into a settler. From the settler the catalyst-complex is recycled to the reactor and the organic phase is washed with water and a caustic solution to remove any remaining catalyst. The waste aqueous phase (from the treatment of the organic phase) is neutralised and aluminium hydroxide is recovered and disposed as landfill or calcinated to recover aluminium oxide. After the washing treatment the ethylbenzene is purified. Recovered benzene and polyethylbenzenes are recycled. The heavier compounds are used as fuel.

- **The Monsanto process.** Resembles the Union Carbide/Badger process. The reaction is operated at higher temperature, so less catalyst is needed. No catalyst complex phase is present, since all catalyst is dissolved, resulting in higher selectivity and higher overall yield. Two reactors are used: one with only dry benzene, ethylene, catalyst and promotor; the second with the effluent from the first reactor plus (recycled) polyethylbenzenes. The effluent of the second reactor is washed with water and a caustic solution to remove the catalyst complex. Further processing as above.

The vapour-phase operation of ethylbenzene can be operated in several ways:

- **The simple process.** A solid catalyst e.g. alumina on silica gel is used. Operation temperatures are $>300\text{ }^{\circ}\text{C}$; pressures $>6000\text{ kPa}$. High benzene/ethylene ratios are used to minimise formation of higher alkylated ethylbenzenes. A small dealkylation unit, like the liquid phase process, is used to obtain higher overall yield.
- **The Mobil/Badger process.** Fresh ethylene, preheated benzene and recycled alkyl-aromatics are led to a single fixed bed reactor containing a ZSM-5 catalyst. In the reactor simultaneous transalkylations occur. Operation conditions are high temperatures and moderate pressures. Two reactors are used: one in use, the other being regenerated. After the reactor a prefractionator is used to separate benzene, volatile components and ethylbenzene and high boilers. The top of the prefractionator is cooled; the condensate (mainly benzene) is recycled to the reactor, the uncondensable components are vented or used as fuel. The bottom product consists of crude ethylbenzene; this crude product is purified and recovered benzene and polyethylbenzenes are recycled to the reactor. The residue from the purification is used as fuel.
- **The Alkar process.** This process is used for feeds with low ethylene concentrations. The reactor contains a solid acid catalyst of activated alumina with some BF_3 . A separate transalkylation reactor is used to reform polyethylbenzenes. Before the purification the non-reactive gasses are removed in a flash drum. During the purification of ethylbenzene, benzene and polyethylbenzenes are recovered and recycled.

The major emissions to air are methane, ethylene, benzene and toluene. Methane is released due to combustion, ethylene due to leakage loss and combustion, benzene due to leakage loss and toluene due to leakage and storage loss.

The losses due to leakage can be limited by using certain types of seals and application of double seals near pumps.

Table 3.55 Tier 2 emission factors for source category 2.B.5.a Other chemical industry, ethylbenzene (040518)

Tier 2 emission factors					
NFR Source Category	Code	Name			
	2.B.5.a	Other chemical industry (Please specify the sources included/excluded in the notes)			
Fuel	NA				
SNAP (if applicable)	040518	Ethylbenzene			
Technologies/Practices					
Region or regional conditions					
Abatement technologies					
Not applicable					
Not estimated	NOx, CO, SOx, NH3, TSP, PM10, PM2.5, Pb, Cd, Hg, As, Cr, Cu, Ni, Se, Zn, Aldrin, Chlordane, Chlordecone, Dieldrin, Endrin, Heptachlor, Heptabromo-biphenyl, Mirex, Toxaphene, HCH, DDT, PCB, PCDD/F, Benzo(a)pyrene, Benzo(b)fluoranthene, Benzo(k)fluoranthene, Indeno(1,2,3-cd)pyrene, Total 4 PAHs, HCB, PCP, SCCP				
Pollutant	Value	Unit	95% confidence interval		Reference
			Lower	Upper	
NM VOC	0.1	kg/ton produced	0.001	2	IPPC BREF LVOC (2003)

Phthalic anhydride (040519)

Phthalic anhydride is manufactured from either o-xylene or naphthalene. Several types of oxidation are used to produce phthalic anhydride.

Using o-xylene as feed, two processes are used:

- Fixed bed vapour-phase oxidation. The feed is led into a multi-tubular reactor. This is operated at 380–400 °C and ambient pressure. The catalyst used is vanadium oxide with titanium dioxide on a non-porous carrier. The o-xylene inlet concentration in the air feed is above the explosion limit of o-xylene. The yield is 1.09 kg phthalic anhydride per kg pure o-xylene.
- Liquid phase oxidation. Acetic acid is used as solvent. The operation temperature is 150–245 °C and the catalyst is a mixture of cobalt, manganese and bromine salts. Under these conditions o-xylene is oxidised to phthalic acid. In the next step phthalic acid is dehydrated to phthalic anhydride. This process has the advantage of high yield but the disadvantage of high capital costs.

Table 3.56 Tier 2 emission factors for source category 2.B.5.a Other chemical industry, phthalic anhydride, using o-xylene as feed (040519)

Tier 2 emission factors					
NFR Source Category	Code	Name			
	2.B.5.a	Other chemical industry (Please specify the sources included/excluded in the notes)			
Fuel	NA				
SNAP (if applicable)	040519	Phthalic anhydride			
Technologies/Practices	Using o-xylene as feed				
Region or regional conditions					
Abatement technologies					
Not applicable					
Not estimated	NOx, CO, SOx, NH3, TSP, PM10, PM2.5, Pb, Cd, Hg, As, Cr, Cu, Ni, Se, Zn, Aldrin, Chlordane, Chlordecone, Dieldrin, Endrin, Heptachlor, Heptabromo-biphenyl, Mirex, Toxaphene, HCH, DDT, PCB, PCDD/F, Benzo(a)pyrene, Benzo(b)fluoranthene, Benzo(k)fluoranthene, Indeno(1,2,3-cd)pyrene, Total 4 PAHs, HCB, PCP, SCCP				
Pollutant	Value	Unit	95% confidence interval		Reference
			Lower	Upper	
NM VOC	1.3	kg/ton produced	0.6	2.6	US EPA AP42

Likewise, using naphthalene as feed, two processes are used:

- Fixed bed vapour phase oxidation. Operation conditions are the same as for the o-xylene fixed bed oxidation, except for the catalyst. Vanadium oxide and alkali metal on silica support is used as catalyst. The yield is 0.9–0.96 kg phthalic anhydride per kg naphthalene.
- Fluidised bed vapour-phase oxidation. This is a process at lower temperature: 340–385 °C. A low activity catalyst of vanadium oxide on silica gel is used. The yield is lower as for the fixed bed process.

Phthalic anhydride recovery and purification from vapour phase oxidations

The reactor outlet is fed to a switch condenser. The tubes in the condensers are first cooled to solidify the phthalic anhydride on the outside of the tubes and then hot oil is circulated through the tubes. This causes the phthalic anhydride to melt and the liquid is collected in a tank. The purification section consists of two columns. Both are operated under vacuum. The first column removes the low boiling by-products (maleic, benzoic, phthalic and citraconic acid) and the second the high boiling products. Total by-product production is less than 1 wt.% of the phthalic anhydride production.

Table 3.57 Tier 2 emission factors for source category 2.B.5.a Other chemical industry, phthalic anhydride, using naphthalene as feed (040519)

Tier 2 emission factors					
	Code	Name			
NFR Source Category	2.B.5.a	Other chemical industry (Please specify the sources included/excluded in the notes)			
Fuel	NA				
SNAP (if applicable)	040519	Phthalic anhydride			
Technologies/Practices	Using naphthalene as feed				
Region or regional conditions					
Abatement technologies					
Not applicable					
Not estimated	NOx, CO, SOx, NH3, TSP, PM10, PM2.5, Pb, Cd, Hg, As, Cr, Cu, Ni, Se, Zn, Aldrin, Chlordane, Chlordecone, Dieldrin, Endrin, Heptachlor, Heptabromo-biphenyl, Mirex, Toxaphene, HCH, DDT, PCB, PCDD/F, Benzo(a)pyrene, Benzo(b)fluoranthene, Benzo(k)fluoranthene, Indeno(1,2,3-cd)pyrene, Total 4 PAHs, HCB, PCP, SCCP				
Pollutant	Value	Unit	95% confidence interval		Reference
			Lower	Upper	
NM VOC	6	kg/ton produced	3	12	US EPA AP42

Acrylonitrile (040520)

Acrylonitrile is made by the catalytic ammoxidation⁽¹⁰⁾ of propylene in the vapour phase. Some plants still use the older route, namely addition of hydrogen cyanide to acetylene.

Acrylonitrile is produced by reaction of propylene with ammonia and oxygen. For this process a fluid bed reactor with a solid catalyst is used. It is a single pass process meaning that no recycling is used. The propylene conversion is 98 %. Operating conditions are a temperature of 400–510 °C and pressure of 150–300 kPa; the catalyst used is a mix of metal oxides, most commonly bismuth and molybdenum oxides with traces of other metal oxides. The reactor effluent is quenched with water in a counter current absorber and unreacted ammonia is neutralised with sulphuric acid. The resulting ammonium sulphate can be recovered (and used as a fertiliser). The absorber off-gas containing primarily nitrogen, carbon monoxide, carbon dioxide and unreacted hydrocarbons is vented or passed through an incinerator to combust the hydrocarbons and carbon monoxide and then vented. The acrylonitrile-containing solution from the absorber is separated in several

⁽¹⁰⁾ Ammoxidation: oxidative reaction of ammonia with an aliphatic group.

columns to produce: acrylonitrile, crude hydrogen cyanide, crude acetonitrile and a fraction with heavy impurities. The acetonitrile is either incinerated or purified for use as solvent.

The major emissions to air are acrylonitrile, ethylene, methane and halogenated hydrocarbons. The halogenated hydrocarbons are released due to cleaning; the acrylonitrile is released in several sections of the plant; methane is released due to leakage; ethylene is released due to combustion.

The losses due to leakage can be limited by using certain types of seals and the application of double seals near pumps.

The proposed emission factor for use in calculating the NMVOC emission from an acrylonitrile plant is 1 kg/ton. For more information see also the BREF document on Large Volume Organic Chemicals, which describes the production of acrylonitrile as one of the illustrative processes (EC, 2003b).

Table 3.58 Tier 2 emission factors for source category 2.B.5.a Other chemical industry, acrylonitrile (040520)

Tier 2 emission factors					
	Code	Name			
NFR Source Category	2.B.5.a	Other chemical industry (Please specify the sources included/excluded in the notes)			
Fuel	NA				
SNAP (if applicable)	040520	Acrylonitrile			
Technologies/Practices					
Region or regional conditions					
Abatement technologies					
Not applicable					
Not estimated		NOx, CO, SOx, NH3, TSP, PM10, PM2.5, Pb, Cd, Hg, As, Cr, Cu, Ni, Se, Zn, Aldrin, Chlordane, Chlordane, Dieldrin, Endrin, Heptachlor, Heptabromo-biphenyl, Mirex, Toxaphene, HCH, DDT, PCB, PCDD/F, Benzo(a)pyrene, Benzo(b)fluoranthene, Benzo(k)fluoranthene, Indeno(1,2,3-cd)pyrene, Total 4 PAHs, HCB, PCP, SCCP			
Pollutant	Value	Unit	95% confidence interval		Reference
			Lower	Upper	
NMVOC	1	kg/ton produced	0.44	100	Guidebook (2006)

Glyoxylic acid (040523)

Glyoxylic acid is formed by organic oxidation of glycolic acid or ozonolysis of maleic acid.

Table 3.59 Tier 2 emission factors for source category 2.B.5.a Other chemical industry, glyoxylic acid (040523)

Tier 2 emission factors					
	Code	Name			
NFR Source Category	2.B.5.a	Other chemical industry (Please specify the sources included/excluded in the notes)			
Fuel	NA				
SNAP (if applicable)	040523	Glyoxylic acid			
Technologies/Practices					
Region or regional conditions					
Abatement technologies					
Not applicable					
Not estimated		NOx, CO, NMVOC, SOx, NH3, TSP, PM10, PM2.5, Pb, Cd, Hg, As, Cr, Cu, Ni, Se, Zn, Aldrin, Chlordane, Chlordane, Dieldrin, Endrin, Heptachlor, Heptabromo-biphenyl, Mirex, Toxaphene, HCH, DDT, PCB, PCDD/F, Benzo(a)pyrene, Benzo(b)fluoranthene, Benzo(k)fluoranthene, Indeno(1,2,3-cd)pyrene, Total 4 PAHs, HCB, PCP, SCCP			

Pesticide production (040525) and other (phytosanitary,...) (040527)

Compared to the use of pesticides, the production of pesticides and other phytosanitary agents is not a key category since the production processes are mostly highly controlled in order to control health and environmental effects.

Table 3.60 Tier 2 emission factors for source category 2.B.5.a Other chemical industry, pesticide production (040525) and other (phytosanitary,...) (040527)*

Tier 2 emission factors		
NFR Source Category	Code	Name
Fuel	2.B.5.a	Other chemical industry (Please specify the sources included/excluded in the notes)
SNAP (if applicable)	NA	
Technologies/Practices	040525	Pesticide production
Region or regional conditions		
Abatement technologies		
Not applicable		
Not estimated		NOx, CO, NMVOC, SOx, NH3, TSP, PM10, PM2.5, Pb, Cd, Hg, As, Cr, Cu, Ni, Se, Zn, Aldrin, Chlordane, Chlordecone, Dieldrin, Endrin, Heptachlor, Heptabromo-biphenyl, Mirex, Toxaphene, HCH, DDT, PCB, PCDD/F, Benzo(a)pyrene, Benzo(b)fluoranthene, Benzo(k)fluoranthene, Indeno(1,2,3-cd)pyrene, Total 4 PAHs, HCB, PCP, SCCP

* Emissions of all pesticides are assumed to be negligible compared to product use.

3.3.2.6 Storage, Handling, Transport of Chemical Products (source category 2.B.5.b)

Sources of emissions to air from the storage of liquid and liquefied gases during normal operation comprise:

- emissions during entry and evacuation, i.e. transferring substances in and out of storage (filling and emptying);
- emissions during tank breathing, i.e. due to temperature increases and resulting in vapour space expansions and subsequent emissions;
- fugitive emissions from flange seals, fittings and pumps;
- emissions during sampling;
- emissions from cleaning operations.

Emission sources from dusty bulk materials may be distinguished:

- emissions during loading of the material;
- emissions during discharge of the material;
- emissions during conveyance of the material;
- emissions during storage of the material.

It is assumed that emissions from the storage and handling of chemical products are included in the process emissions as provided in this chapter. For more information on emissions see the IPPC BREF (EC, 2006a).

3.3.3 Abatement

A number of add-on technologies exist that are aimed at reducing the emissions of specific pollutants. The resulting emission can be calculated by replacing the technology-specific emission factor with an abated emission factor as given in the formula:

$$EF_{technologyabated} = (1 - \eta_{abatement}) \times EF_{technologyunabated} \quad (4)$$

The present sub-section presents default abatement efficiencies for a number of abatement options applicable in the chemical industry.

3.3.3.1 Dust capture

The abatement efficiencies given in Table 3.61 below are based on the Coordinated European Particulate Matter Emission Inventory Program (CEPMEIP) (Visschedijk *et al.*, 2004) and calculated with respect to an older plant, with limited control of fugitive sources — only an ESP in the main stack. The comparable emissions in Tier 1 are based on conventional plant technology, for which efficiencies are also provided in Table 3.61.

Table 3.61 Abatement efficiencies ($\eta_{\text{abatement}}$) for source category 2.B.1 Chemical Production

Tier 2 Abatement efficiencies					
	Code	Name			
NFR Source Category	2.B.1 - 2B5	Chemical Industry			
Fuel	NA	not applicable			
SNAP (if applicable)	various	various			
Abatement technology	Pollutant	Efficiency	95% confidence interval		Reference
		Default Value	Lower	Upper	
Conventional plant (installation with average age; conventional dedusting; ESP; wet scrubber; some fugitives capturing)	particle > 10 μm	88%	76%	94%	Visschedijk et al. (2004)
	10 μm > particle > 2.5 μm	81%	62%	90%	Visschedijk et al. (2004)
	2.5 μm > particle	76%	52%	88%	Visschedijk et al. (2004)
Modern plant (BAT): high efficiency ESP or equivalent to control primary sources; fabric filters for fugitive emissions	particle > 10 μm	98%	94%	99%	Visschedijk et al. (2004)
	10 μm > particle > 2.5 μm	96%	81%	99%	Visschedijk et al. (2004)
	2.5 μm > particle	93%	64%	98%	Visschedijk et al. (2004)

3.3.4 Activity data

Information on the production of chemicals, suitable for estimating emissions using the simpler estimation methodology (Tier 1 and 2), is widely available from national statistics or where national statistics are unavailable from United Nations statistical yearbooks.

For a Tier 2 approach these data need to be stratified according the emission factors given above or using country-specific emission factors. Typical sources for these data might be industrial branch organisations within the country or from specific questionnaires to the individual chemical works.

Further guidance is provided in the 2006 IPCC Guidelines for National Greenhouse Gas Inventories, volume 3 on Industrial Processes and Product Use (IPPU), chapter 2.2.1.3, 'Choice of activity statistics'.

3.4 Tier 3 emission modelling and use of facility data

3.4.1 Algorithm

There are two different methods to apply emission estimation methods that go beyond the technology-specific approach described above:

- detailed modelling of the chemical production processes;
- facility-level emission reports.

3.4.1.1 Detailed process modelling

A Tier 3 emission estimate using process details will make separate estimates for the consecutive steps in the chemical production processes:

- handling feedstock;
- chemical handling, reaction and processing;
- final steps to produce the products as they leave the facility.

3.4.1.2 Facility-level data

Where facility-level emissions data of sufficient quality are available, it is good practice to use these data. There are two possibilities:

- facility reports cover all chemical production in the country;
- facility level emission reports are not available for all chemical plants in the country.

If facility level data cover all chemical production in the country, the implied emission factors (reported emissions divided by the national chemical production) should be compared with the default emission factor values or technology-specific emission factors. If the implied emission factors are outside the 95 % confidence intervals for the values given below, it is good practice to explain the reasons for this in the inventory report

If the total annual chemical production in the country is not included in the total of the facility reports, the missing part of the national total emissions from the source category should be estimated, using extrapolation by applying:

$$E_{Total,pollutant} = \sum_{Facilities} E_{Facility,pollutant} + \left(National\ Production - \sum_{Facilities} Production_{Facility} \right) \times EF \quad (5)$$

Depending on the specific national circumstances and the coverage of the facility-level reports as compared to the total national chemical production, the emission factor (*EF*) in this equation should be chosen from the following possibilities, in decreasing order of preference:

- technology-specific emission factors, based on knowledge of the types of technologies implemented at the facilities where facility-level emission reports are not available
- the implied emission factor derived from the available emission reports:

$$EF = \frac{\sum_{Facilities} E_{Facility,pollutant}}{\sum_{Facilities} Production_{Facility}} \quad (6)$$

- the default Tier 1 emission factor. This option should only be chosen if the facility level emission reports cover more than 90 % of the total national production.

3.4.2 Tier 3: emission modelling and use of facility data

Chemical processing facilities are mostly major industrial facilities and emission data for individual plants might be available through a pollutant release and transfer registry (PRTR) or another emission reporting scheme. When the quality of such data is assured by a well developed QA/QC system and the emission reports have been verified by an independent auditing scheme, it is good practice to use such data. If extrapolation is needed to cover all chemical production in the

country either the implied emission factors for the facilities that did report, or the emission factors as provided above could be used.

No generally accepted emission models are available for the chemical industry. Such models could be developed, however, and used in national inventories. If this happens, it is good practice to compare the results of the model with a Tier 1 or Tier 2 estimate to assess the credibility of the model. If the model provides implied emission factors that lie outside the 95 % confidence intervals indicated in the tables above, an explanation for this should be included in the documentation with the inventory and preferably reflected in the Informative Inventory Report.

3.4.3 Activity data

Since PRTRs generally do not report activity data, such data in relation to the reported facility-level emissions are sometimes difficult to find. A possible source of facility level activity might be the registries of emission trading systems.

In many countries national statistics offices collect production data at the facility level but these are in many cases confidential. However, in several countries, national statistics offices are part of the national emission inventory systems and the extrapolation, if needed, could be performed at the statistics office, ensuring that confidentiality of production data is maintained.

4 Data quality

The chemical industry consists of a large number of different processes in which fuels are used for energy purposes but also as chemical feedstock. This means that the categorisation of emissions in combustion and non-combustion is not always simple. If such a split is difficult to obtain, emissions can be reported either under the present source category (2.B) or the industrial combustion source category 1.A.2.c.

4.1 Completeness

In cases where attempts are made to split the emissions from chemical manufacturing between combustion emissions and non-emission combustions, care must be taken to include all emissions.

It is good practice to check whether the emissions reported as 'included elsewhere' (IE) in 2.B are indeed included in the emission reported under source category 1.A.2.c.

4.2 Avoiding double counting with other sectors

In cases where it is possible to split these emissions, it is good practice to do so. However, care must be taken to ensure that the emissions are not double counted.

It is good practice to check that the emissions reported under source categories 2.B.1–2.B.5 are not included in the emissions reported under source category 1.A.2.c.

4.3 Verification

4.3.1 Best Available Technique emission factors

4.3.1.1 Ammonia production (source category 2.B.1)

Table 4.1 BAT-associated emission factors for source category 2.B.1 Ammonia production, conventional reforming processes and reduced primary reforming processes

	Code	Name		
NFR Source Category	2.B.1	Chemical industry, Ammonia production		
Fuel	NA	not applicable		
Pollutant	Value	Unit	95% confidence interval	
			Lower	Upper
Nox	0.32	kg/tonne NH ₃ produced	0.29	0.32

Note:

Emission factor adopted from the IPPC BREF Large Volume Inorganic Chemicals – Ammonia, Acids and Fertilisers (EC, 2006b).

Table 4.2 BAT-associated emission factors for source category 2.B.1 Ammonia production, heat exchange autothermal reforming processes

	Code	Name		
NFR Source Category	2.B.1	Chemical industry, Ammonia production		
Fuel	NA	not applicable		
Pollutant	Value	Unit	95% confidence interval	
			Lower	Upper
NOx	0.175	kg/tonne NH ₃ produced		

Note:

Energy consumption levels associated with BAT are 27.6–31.8 GJ ± 1.5 GJ (LHV)/tonne NH₃.

Emission factors adopted from the IPPC BREF on Large Volume Inorganic Chemicals — Ammonia, Acids and Fertilisers (EC, 2006b).

Carbon black (040409)

In the IPPC BREF on Large Volume Inorganic Chemicals – Solids and Others (EC, 2006c) the BAT conclusion on production of carbon black is the use of low sulphur primary feedstock with a sulphur content in the range of 0.5–1.5 % as a yearly average. The corresponding specific emission level associated with BAT is 10–50 kg SO_x (as SO₂) per tonne of rubber-grade carbon black produced, as a yearly average. These levels are achieved assuming that the secondary feedstock is natural gas. Other liquid or gaseous hydrocarbons can be used as well.

Table 4.3 BAT-associated emission factors for source category 2.B.5.a Other chemical industry, carbon black production

	Code	Name		
NFR Source Category	2.B.5a	Chemical industry, other Chemical Industry, Carbon Black production		
Fuel	NA	not applicable (feedstock gas or other liquid or gaseous hydrocarbons)		
Pollutant	Value	Unit	95% confidence interval	
			Lower	Upper
SOx (as SO ₂)	50	kg SOx/tonne carbon black (rubber grade)	10	50

Titanium dioxide (040410)

For titanium dioxide plants in the EU-25, the following emission factors are consistent with BAT (EC, 2006c).

Table 4.4 BAT-associated emission factors for source category 2.B.5.a Other chemical industry, titanium dioxide production, chloride process

	Code	Name		
NFR Source Category	2.B.5a	Chemical industry, Other Chemical industry, Titanium dioxide production, chloride process ((040410))		
Fuel	NA	not applicable		
Pollutant	Value	Unit	95% confidence interval	
			Lower	Upper
Particulates	0.2	kg/t TiO ₂ pigment	0.1	0.2
HCl	0.1	kg/t TiO ₂ pigment	0.03	0.1
SOx	1.5	kg/t TiO ₂ pigment	1.3	1.7

Table 4.5 BAT-associated emission factors for source category 2.B.5.a Other chemical industry, titanium dioxide production, sulphate process

	Code	Name		
NFR Source Category	2.B.5a	Chemical industry, Other Chemical industry, Titanium dioxide production, sulphate process ((040410))		
Fuel	NA	not applicable		
Pollutant	Value	Unit	95% confidence interval	
			Lower	Upper
Particulates	0.45	kg/t TiO ₂ pigment	0.004	0.45
SOx	3.5	kg/t TiO ₂ pigment	1	6

Chlorine production (040413)

The selected process technology has a major impact on energy use and emissions from the manufacture of chlor-alkali. The Best Available Technique for the production of chlor-alkali is considered to be membrane technology. Non-asbestos diaphragm technology can also be considered as BAT.

Table 4.6 BAT associated emission factors for source category 2.B.5.a Other chemical industry, chlorine production

	Code	Name		
NFR Source Category	2.B.5a	Chemical industry, chlorine, mercury cell		
Fuel	NA	not applicable		
Pollutant	Value	Unit	95% confidence interval	
			Lower	Upper
Hg	0.3	g Hg/tonne Cl ₂ capacit	0.0005	0.3

Note:

The emission factor is adopted from the BREF Chlor-Alkali (EC, 2001).

Polyethylene low density (040506) and polyethylene high density (040507)

Data are taken from the BREF on Polymers (EC, 2006d).

Table 4.7 BAT-associated emission factors for source category 2.B.5.a Other chemical industry, polyethylene low density, new plants

	Code	Name		
NFR Source Category	2.B.5a	Chemical industry, Polyethylene Low Density		
Fuel	NA	not applicable		
Pollutant	Value	Unit	95% confidence interval	
			Lower	Upper
NM _{VO} C	0.8	kg/ Mg	0.7	1.1

Table 4.8 BAT- associated emission factors for source category 2.B.5.a Other chemical industry, polyethylene low density, existing plants

	Code	Name		
NFR Source Category	2.B.5a	Chemical industry, Polyethylene Low Density		
Fuel	NA	not applicable		
Pollutant	Value	Unit	95% confidence interval	
			Lower	Upper
NM _{VO} C	1.5	kg/ Mg	1.1	2.1

Table 4.9 BAT-associated emission factors for source category 2.B.5.a Other chemical industry, polyethylene high density, new plants

	Code	Name		
NFR Source Category	2.B.5a	Chemical industry, Polyethylene High Density		
Fuel	NA	not applicable		
Pollutant	Value	Unit	95% confidence interval	
			Lower	Upper
NM _{VO} C	0.4	kg/ Mg	0.3	0.5

Table 4.10 BAT-associated emission factors for source category 2.B.5.a Other chemical industry, polyethylene high density, existing plants

	Code	Name		
NFR Source Category	2.B.5a	Chemical industry, Polyethylene High Density		
Fuel	NA	not applicable		
Pollutant	Value	Unit	95% confidence interval	
			Lower	Upper
NM _{VO} C	1.2	kg/ Mg	0.5	1.8

Polyvinylchloride (040508)

Data are taken from the BREF on Polymers (EC, 2006d).

Table 4.11 BAT-associated emission factors for source category 2.B.5.a Other chemical industry, polyvinylchloride S-PVC

	Code	Name		
NFR Source Category	2.B.5a	Chemical industry, Polyvinylchloride S-PVC		
Fuel	NA	not applicable		
Pollutant	Value	Unit	95% confidence interval	
			Lower	Upper
NM VOC	32	g/ Mg	18	45

Table 4.12 BAT-associated emission factors for source category 2.B.5.a Other chemical industry, polyvinylchloride E-PVC

	Code	Name		
NFR Source Category	2.B.5a	Chemical industry, Polyvinylchloride E-PVC		
Fuel	NA	not applicable		
Pollutant	Value	Unit	95% confidence interval	
			Lower	Upper
NM VOC	300	g/ Mg	100	500

Polystyrene (040511)

Data are taken from the BREF on Polymers (EC, 2006d).

Table 4.13 BAT-associated emission factors for source category 2.B.5.a Other chemical industry, polystyrene (HIPS)

	Code	Name		
NFR Source Category	2.B.5a	Chemical industry, Polystyrene (HIPS)		
Fuel	NA	not applicable		
Pollutant	Value	Unit	95% confidence interval	
			Lower	Upper
NM VOC	85	g/ Mg		

Table 4.14 BAT-associated emission factors for source category 2.B.5.a Other chemical industry, polystyrene (GPPS)

	Code	Name		
NFR Source Category	2.B.5a	Chemical industry, Polystyrene (GPPS)		
Fuel	NA	not applicable		
Pollutant	Value	Unit	95% confidence interval	
			Lower	Upper
NM/OC	85	g/ Mg		

Table 4.15 BAT-associated emission factors for source category 2.B.5.a Other chemical industry, polystyrene (EPS)

	Code	Name		
NFR Source Category	2.B.5a	Chemical industry, Polystyrene (EPS)		
Fuel	NA	not applicable		
Pollutant	Value	Unit	95% confidence interval	
			Lower	Upper
NM/OC	0.58	g/ Mg	0.45	0.7

Styrene butadiene (040512), styrene-butadiene latex (040513) and styrene-butadiene rubber (SBR) (040514)

Data are taken from the BREF on Polymers (EC, 2006d).

Table 4.16 BAT-associated emission factors for source category 2.B.5.a Other chemical industry, styrene-butadiene latex (040513)

	Code	Name		
NFR Source Category	2.B.5a	Chemical industry, Styrene-butadiene latex E-SBR (040513)		
Fuel	NA	not applicable		
Pollutant	Value	Unit	95% confidence interval	
			Lower	Upper
NM/OC	0.27	g/ ton produced	0.17	0.37

4.4 Developing a consistent time series and recalculation

For Tier 3 using facility-level data, it might occur that a different selection of facility-level data is included in different years. This can lead to time series inconsistencies. Moreover, PRTR data are generally available for specific years only. Splicing such recent reported data under E-PRTR/EPER with historical data could be used to get consistent time series. Splicing could be used for both the activity data and the country-specific emission factors.

Unexpected discontinuities in time series can occur when specific chemical works come into operation or are closed in specific years. If this happens, it is good practice to clearly document such explanations in the inventory archives.

4.5 Uncertainty assessment

It is rather difficult to assess current uncertainties of emission estimates for pollutants emitted during chemical processing. The uncertainties of emission estimates can be assessed in a similar way as the uncertainties of the estimates for the fossil fuel combustion (see chapter 1.A.2.c).

4.5.1 Emission factor uncertainties

No specific issues

4.5.2 Activity data uncertainties

No specific issues

4.6 Inventory quality assurance/quality control (QA/QC)

Emissions from chemical processing production, as discussed in this sub-sector, only include the emissions due to other causes than the combustion of fuels. The emissions of fuel combustion are to be reported under source category 1.A.2.c in the industrial combustion sector. It is good practice to check whether the production data, used in this sub-sector, are consistent with the associated fuel use as reported in the industrial combustion sector.

4.7 Gridding

Chemical production plants should be considered as point sources if plant-specific data are available. Otherwise national emissions should be disaggregated on the basis of plant capacity, employment or population statistics.

4.8 Reporting and documentation

No specific issues.

5 Glossary

Unit operation	A characteristic defined sub-part of a process
Process	A series of unit operations that form a production process
EO	ethylene oxide
EDC	1,2-dichloroethane (ethylene dichloride)
Batch processing	Unit operations are operated one by one, batch-wise. Reactions are stopped when the yield is reached.
Continuous processing	Unit operations take place in a continuous flow through different types of equipment

6 References

- Bol, B. and Kohnen, E.A.E.M., 1993. *Productie van Zwavelzuur*. RIVM-report 736301143; RIZA-report 92.003/43.
- Cheremisinoff, N.P., 2002. *Handbook of air pollution prevention and control*. ISBN 0-7506-7499-7
- CITEPA (ed.), 1992. *CORINAIR - Emission Factor Handbook, part 1: Default Emission Factors from stationary sources*.
- EGTEL, 2005. *Synopsis sheet on organic chemical industry downstream units organic chemical industry except steam cracking, PVC production by suspension process and speciality organic chemical industry*. Expert Group on Techno-Economic Issues.
- EC, 2001. *Integrated Pollution Prevention and Control Best Available Technique Reference Document: Chlor-Alkali Manufacturing Industry*. European Commission Joint Research Centre, December 2001.
- EC, 2003a. *Integrated Pollution Prevention and Control Best Available Technique Reference Document: Common Waste Water and Waste Gas Treatment and Management Systems in the Chemical Sector*. European Commission Joint Research Centre
- EC, 2003b. *Integrated Pollution Prevention and Control Best Available Technique Reference Document: Large Volume Organic Chemical Industry*. European Commission Joint Research Centre, February 2003
- EC, 2006a. *Integrated Pollution Prevention and Control Best Available Technique Reference Document: Emissions from Storage*. European Commission Joint Research Centre, July 2006
- EC, 2006b. *Integrated Pollution Prevention and Control Best Available Technique Reference Document: Manufacture of Large Volume Inorganic Chemicals – Ammonia, Acids and Fertilisers*. European Commission Joint Research Centre, December 2006
- EC, 2006c. *Integrated Pollution Prevention and Control Best Available Technique Reference Document: Manufacture of Large Volume Inorganic Chemicals – Solids and Others Industry*. European Commission Joint Research Centre, October 2006
- EC, 2006d. *Integrated Pollution Prevention and Control Best Available Technique Reference Document: Polymers*. European Commission Joint Research Centre, October 2006
- EC, 2007. *European Pollutant Emission Register. Second EPER review report*. European Commission. Available at: www.eper.eea.europa.eu/eper [Accessed 9 October 2009]
- EPA, 1993. *Compilation of Air Pollutant Emission Factors (AP42), Volume 1: Stationary Point and Area Sources, Fifth Edition*. United States Environment Protection Agency. Available at: www.epa.gov/ttn/chief/ap42 [Accessed 9 October 2009]

Guidebook, 2006. EMEP/CORINAIR Emission Inventory Guidebook, version 4 (2006 edition). European Environmental Agency, Technical report No. 11/2006.⁽¹¹⁾

Theloke J., Kummer, U., Nitter, S., Geftler, T. and Friedrich, R., 2008. 'Überarbeitung der Schwermetallkapitel'. In: *CORINAIR Guidebook zur Verbesserung der Emissionsinventare und der Berichterstattung im Rahmen der Genfer Luftreinhaltekonvention*. Report for Umweltbundesamt, April 2008.

Visschedijk, A.J.H., Pacyna, J., Pulles, T., Zandveld, P. and Denier van der Gon, H., 2004. 'Coordinated European Particulate Matter Emission Inventory Program (CEPMEIP)'. In: Dilara, P. *et al.* (eds.), *Proceedings of the PM emission inventories scientific workshop, Lago Maggiore, Italy, 18 October 2004*. EUR 21302 EN, JRC, pp. 163–174.

7 Point of enquiry

Enquiries concerning this chapter should be directed to the relevant leader(s) of the Task Force on Emission Inventories and Projection's expert panel on combustion and industry. Please refer to the TFEIP website (www.tfeip-secretariat.org) for the contact details of the current expert panel leaders.

⁽¹¹⁾ When emission factors are referenced with Guidebook 2006, whether these consist of compilations of different sets of emission factors from the 2006 version Guidebook or the reference in the 2006 version of the Guidebook is always specified – users should check the Guidebook 2006.